

# Technical Manual

## WDGA absolute rotary encoders with EtherNet/IP interface



**EtherNet/IP**

**EnDra**<sup>®</sup>  
Technologie

## Legal information



### **Wachendorff Automation GmbH & Co. KG**

Industriestrasse 7  
65366 Geisenheim  
Germany

Tel: +49 (0) 67 22 / 99 65 25

E-mail: [support-wa@wachendorff.de](mailto:support-wa@wachendorff.de)

Website: [www.wachendorff-automation.de](http://www.wachendorff-automation.de)

Wiesbaden District Court HRA 8377, VAT ID No: DE 814567094

Managing Director: Robert Wachendorff

### **Warranty waiver, right of amendment, copyright:**

Wachendorff Automation accepts no liability or warranty for the correctness of this manual, or for any direct or indirect damage that may arise from it. In the pursuit of constant innovation and cooperation with customers, we reserve the right to amend technical data or content at any time.

Wachendorff Automation asserts copyright over this manual. It may not be modified, added to, reproduced or shared with third parties without prior written consent.

### Comments:

Should you have any corrections, notes or requests for changes, please send them to us. Send your comments to: [support-wa@wachendorff.de](mailto:support-wa@wachendorff.de)

<b>1</b>	<b>Introduction .....</b>	<b>1</b>
1.1	About this manual.....	1
1.1.1	Symbols .....	2
1.1.2	You will not find the following in this manual: .....	2
1.2	Product assignment.....	3
1.3	Specifications .....	4
1.4	Scope of delivery .....	4
<b>2</b>	<b>Safety information .....</b>	<b>5</b>
2.1	General safety information .....	5
2.2	Intended use.....	5
2.3	Safe working.....	6
2.4	Disposal.....	6
<b>3</b>	<b>Device description.....</b>	<b>7</b>
3.1	General information .....	7
3.2	EtherNet/IP .....	7
3.3	WDGA — basic principles .....	7
3.3.1	Singleturn — ST (QuattroMag®).....	8
3.3.2	Multiturn — MT (EnDra®) .....	8
3.3.3	Direction of rotation.....	8
3.3.4	Preset .....	8
3.3.5	Scaling .....	9
3.4	Connection assignments for EtherNet/IP encoders.....	11
3.4.1	BI2 — bus cover with 3x M12x1.....	11
3.5	LEDs and signalling.....	12
3.6	MAC address and IP address.....	13
<b>4</b>	<b>EtherNet/IP .....</b>	<b>14</b>
4.1	Functions overview.....	14
4.2	List of all classes .....	14
4.3	Process and configuration data .....	15
4.3.1	Process data overview (Assemblies) .....	15
4.3.2	Process data Assembly 1.....	16
4.3.3	Process data Assembly 2.....	17
4.3.4	Process data Assembly 3.....	18
4.3.5	Process data Assembly 100.....	19

4.3.6	Process data Assembly 101.....	20
4.3.7	Configuration Assembly 110 .....	22
4.4	Class attributes.....	25
4.4.1	Identity Object 01h.....	25
4.4.2	Position Sensor Object 23h.....	26
<b>5</b>	<b>Webserver .....</b>	<b>35</b>
5.1	General.....	35
5.2	Information .....	36
5.2.1	Overview .....	36
5.2.2	Versions.....	37
5.3	Configuration .....	38
5.3.1	Network.....	38
5.3.2	Encoder.....	38
5.3.3	Firmware Update .....	39
5.4	Licence information .....	42
5.5	Contact.....	43
<b>6</b>	<b>Commissioning.....</b>	<b>44</b>
6.1	General.....	44
6.2	Deactivating DHCP mode and assigning an IP address.....	44
6.3	Activating DHCP mode.....	47
6.4	Integration into a Studio 5000 project.....	48
6.4.1	Parameterization via Configuration Assembly.....	55
6.4.2	Parameterization via Explicite Messaging.....	58
6.5	Further exemplary configuration options .....	64
6.5.1	Position limits .....	64
6.5.2	Preset Attribut 140h .....	66
<b>7</b>	<b>Technical data.....</b>	<b>67</b>
7.1	Properties .....	67
7.2	Dimensions.....	68
7.2.1	WDGA 58B .....	68
7.2.2	WDGA 58F.....	68
7.2.3	WDGA 58E .....	69
7.2.4	WDGA 58A .....	69
7.2.5	WDGA 58D .....	70
<b>8</b>	<b>Technical support.....</b>	<b>71</b>



## Index of figures

Figure 3.1: WDGA with EtherNet/IP bus cover .....	7
Figure 5.1: Overview .....	36
Figure 5.2: Versions .....	37
Figure 5.3: Network .....	38
Figure 5.4: Encoder .....	38
Figure 5.5: Firmware update.....	39
Figure 5.6: Firmware update - choose file .....	40
Figure 5.7: Firmware update - Transferring file.....	41
Figure 5.8: Firmware update - Successful .....	41
Figure 5.9: Firmware update - Failed.....	42
Figure 5.10: Licence information .....	42
Figure 5.11: Contact information .....	43
Figure 6.1: BootP-DHCP-Tool .....	44
Figure 6.2: Set IP address and device name.....	45
Figure 6.3: IP address and device name successfully set .....	45
Figure 6.4: DHCP deactivated .....	46
Figure 6.5: Webserver available .....	46
Figure 6.6: Set MAC and IP address .....	47
Figure 6.7: DHCP activated .....	47
Figure 6.8: Main menu.....	48
Figure 6.9: Tools -> EDS Hardware Installation Tool.....	48
Figure 6.10: EDS Hardware Installation Tool.....	49
Figure 6.11: Register EDS file .....	49
Figure 6.12: Pick EDS file.....	49
Figure 6.13: EDS installation .....	50
Figure 6.14: Installation successful.....	50
Figure 6.15: Project navigation .....	51
Figure 6.16: Hardware catalogue .....	51
Figure 6.17: General.....	52
Figure 6.18: Choose assembly .....	52
Figure 6.19: Encoder configuration successful .....	53
Figure 6.20: Position value .....	54
Figure 6.21: Module definition .....	55
Figure 6.22: Controller tags .....	56
Figure 6.23: Configuration Assembly.....	56
Figure 6.24: Example configuration .....	57
Figure 6.25: Encoder information .....	57
Figure 6.26: Example new program.....	58
Figure 6.27: Parameters and tags .....	58
Figure 6.28: Parameters and tags .....	59
Figure 6.29: Rung edit.....	59
Figure 6.30: Rung edit.....	59
Figure 6.31: Rung edit.....	60
Figure 6.32: Rung edit.....	60
Figure 6.33: MSG block configuration .....	61

Figure 6.34: MSG block path configuration.....	61
Figure 6.35: Configure main program .....	62
Figure 6.36: Parameters and tags .....	62
Figure 6.37: Configuration successful .....	63
Figure 6.38: Webserver after successful configuration .....	63
Figure 6.39: Message position low limit .....	64
Figure 6.40: MSG position high limit .....	65
Figure 6.41: Assembly 100 .....	65
Figure 6.42: Position state register inside work are .....	66
Figure 6.43: Position state register outside work area .....	66
Figure 7.1: Dimensions WDGA 58B .....	68
Figure 7.2: Dimensions WDGA 58F .....	68
Figure 7.3: Dimensions WDGA 58E .....	69
Figure 7.4: Dimensions WDGA 58A .....	69
Figure 7.5: Dimension WDGA 58D .....	70

## Index of tables

Table 3.1: Connection assignment — BI2 .....	11
Table 3.2: LED signal .....	12
Table 4.1: Functions .....	14
Table 4.2: List of all classes.....	14
Table 4.3: Process data overview.....	15
Table 4.4: Assembly 1 .....	16
Table 4.5: Assembly 2 .....	17
Table 4.6: Assembly 3 .....	18
Table 4.7: Assembly 100 .....	19
Table 4.8: Assembly 101 .....	21
Table 4.9: Config Assembly 110.....	23
Table 4.10: Identity Object.....	25
Table 4.11: Position Sensor Object .....	32
Table 4.12: CAM state register .....	32
Table 4.13: CAM state register .....	33
Table 4.14: CAM enable register .....	33
Table 4.15: CAM polarity register .....	33
Table 6.1: Configurations.....	62



# 1 Introduction

## 1.1 About this manual

This technical manual describes the configuration and mounting possibilities for absolute-value encoders with a EtherNet/IP interface for firmware version greater 1.02 produced by Wachendorff Automation. It supplements the other publicly available Wachendorff automation documents, e.g. data sheets, assembly instructions, leaflets, catalogues and flyers.

Ensure that you read the manual before commissioning — check beforehand that you have the latest version of the manual.

When reading, pay particular attention to the information, important notices and warnings that are marked with the corresponding symbols (see 1.1.1).



This manual is intended for persons with technical knowledge in the handling of sensors, EtherNet/IP interfaces and automation elements. If you do not have any experience in this field, request the assistance of experienced personnel before proceeding.

Keep the information provided with our product in a safe place so that you can refer to it at a later date as necessary.



- The contents of this manual are arranged in a practice-oriented manner.
- For optimum use of the device, all information in the following sections is important and should be read.

### 1.1.1 Symbols

	<ul style="list-style-type: none"><li>• The INFO symbol indicates a section that contains particularly important information for advanced use of the device.</li></ul>
	<ul style="list-style-type: none"><li>• The IMPORTANT symbol is shown next to a section of text that describes a method for solving a particular problem.</li></ul>
	<ul style="list-style-type: none"><li>• The WARNING symbol indicates that the adjacent instructions must be observed to ensure correct use of the device and to protect the user against hazards.</li></ul>

### 1.1.2 You will not find the following in this manual:

- Basic information about automation technology
- System planning
- Risks (availability, safety)
- Shielding concepts
- Reflections
- Repeaters
- Network configuration
- Bus cycle times
- FMA management services
- Transmission services
- Telegram types

## 1.2 Product assignment

This manual relates to the following encoder types produced by Wachendorff Automation:

### Solid shaft absolute encoders:

- WDGA 58A ETHERNET/IP (BI2) — (with bus cover)
- WDGA 58B ETHERNET/IP (BI2) — (with bus cover)
- WDGA 58D ETHERNET/IP (BI2) — (with bus cover)
- WDGA 58F ETHERNET/IP (BI2) — (with bus cover)

### Hollow shaft absolute encoders:

- WDGA 58E ETHERNET/IP (BI2) — (with bus cover)



- Wachendorff's EtherNet/IP product range can be found on our website: [www.wachendorff-automation.com](http://www.wachendorff-automation.com)

## 1.3 Specifications

An encoder is a sensor that is designed to detect angular positions (singleturn) and revolutions (multiturn). The measured data and variables are processed by the encoder and provided as electrical output signals for the connected peripherals.

The patented technologies QuattroMag® (for singleturn) and EnDra® (for multiturn) are used in the WDGA series. As a result, the WDGA-series encoders from Wachendorff are maintenance-free and very eco-friendly.

The encoders whose article descriptions are listed in section 1.2 communicate via the EtherNet/IP interface.

## 1.4 Scope of delivery

The scope of delivery depends on the product variants and the details of your order. Before commissioning, check the contents of the delivery for completeness.

As a rule, the WDGA product range with a EtherNet/IP interface includes the following items:

- WDGA with EtherNet/IP (with bus cover)
- Assembly instructions



- The corresponding EDS file and data sheet can be downloaded from the internet:

[www.wachendorff-automation.com](http://www.wachendorff-automation.com)

## 2 Safety information

### 2.1 General safety information

	<ul style="list-style-type: none"><li>• When commissioning the encoder, ensure that you observe the assembly instructions, manual and data sheet.</li><li>• Failure to observe the safety instructions may lead to malfunctions, property damage and personal injury!</li><li>• Observe the operating instructions provided by the machine's manufacturer.</li></ul>
---	--

### 2.2 Intended use

Rotary encoders are components that are intended for installation in machines. Before commissioning (operation in accordance with the intended use), it must be determined that the machine as a whole corresponds to the EMC and Machine Directive.

A rotary encoder is a sensor that is designed to detect angular positions and revolutions and must only be used for this purpose! Wachendorff Automation manufactures and distributes encoders for use in non-safety-relevant industrial applications.

	<ul style="list-style-type: none"><li>• The encoder must not be operated outside the specified limit parameters (see data sheet).</li></ul>
---	---

## 2.3 Safe working

The installation and mounting of the encoder must only be carried out by a qualified electrician.

For the construction of electrical installations, all relevant national and international regulations must be strictly observed.

Failure to commission the encoder correctly may result in malfunction or failure.

	<ul style="list-style-type: none"><li>• All electrical connections must be tested before commissioning.</li><li>• Appropriate safety measures must be taken to ensure that no persons are harmed and no damage to the system or operating equipment occurs in the event of a failure or malfunction.</li></ul>
---	--

## 2.4 Disposal

Devices that are no longer needed or are defective must be disposed of by the user in proper compliance with the country-specific laws. It must be taken into consideration that this is a special waste of electronics and that disposal is not permitted via normal household waste.

There is no obligation by the manufacturer to take the device back. If you have any questions regarding proper disposal, contact a disposal specialist in your area.

## 3 Device description

### 3.1 General information

Various mechanical variants of the WDGA-series encoders with EtherNet/IP are available. The required variant is determined by the need for a bus cover, the flange design and the shaft type (solid or hollow). The size is specified as 58 mm by the diameter at the flange. The following figure shows examples of WDGA-series encoders with EtherNet/IP.



Figure 3.1: WDGA with EtherNet/IP bus cover

The solid or hollow shaft is connected to the rotating component whose angular position or rotational speed is to be measured. Cable or plug outlets create the interface for connection to the EtherNet/IP network. The status LEDs mounted in the cover signal the various encoder states during operation. They assist with configuration of the encoder and troubleshooting in the field. The flange holes or supplied spring sheets are used for attachment to the machine and during the respective application.

### 3.2 EtherNet/IP

EtherNet/IP is a real-time Ethernet, which was developed by Allen-Bradley and is managed today as an open standard by the Open DeviceNet Vendor Association (ODVA). It is based on the CIP standard (Common Industrial Protocol) and is used for the transmission of cyclic I/O data, as well as acyclic parameter data.

EtherNet/IP offers different topologies, but mostly an active star or ring topology is used. With the ring topology, the DLR ("Device Level Ring") can be used to prevent a total failure in the network due to a cable break, for example.

### 3.3 WDGA — basic principles

The following sections describe the basic functions of an absolute encoder.

Unlike incremental encoders, absolute-value encoders output their position value as a digital number via a fieldbus. A distinction is made here between singleturn and multiturn encoders.

In addition to simply outputting the position value, most encoders permit a certain degree of parametrization, such as selecting the positive direction of rotation, setting the position value to a reference value at a fixed physical position, and scaling the position value to an arbitrary resolution and a limited measuring range. This reduces the required complexity of the control program as well as the computational burden on the controller.

### **3.3.1 Singleturn — ST (QuattroMag®)**

Measurement of the angle from 0° to 360° by means of a shaft represents the minimum functionality of a rotary encoder. The sensor system is based on optical or magnetic sampling of a measuring graduation on the encoder shaft.

The WDGA encoders from Wachendorff feature the new QuattroMag® magnetic technology, which provides maximum precision and resolution for a singleturn encoder.

### **3.3.2 Multiturn — MT (EnDra®)**

A multiturn encoder allows the number of revolutions to be recorded. This is achieved via a rotation counter. The WDGA encoders include EnDra® technology, which ensures that the corresponding information is retained, even in a voltage-free state. This means that buffer batteries and gearboxes, which require a comparatively large installation space and a correspondingly high degree of maintenance, are no longer needed.

### **3.3.3 Direction of rotation**

The positive direction of rotation can be reversed by a simple two's complement of the position value (invert every bit and add "1").

### **3.3.4 Preset**

The desired position value can be assigned to the encoder at a specific physical position. This must be within the measuring range so that the position value is correlated with a physical reference position. For this purpose, the difference between the current position value and the desired value is calculated. The result is stored in non-volatile memory and added to the position value as an offset.



### 3.3.5 Scaling

To ensure that the position value exactly matches the variables to be physically measured, an adjustment can be carried out via the scaling parameters. The scalable parameters are "Measuring units per revolution (MUPR)" and "Total measuring range in measuring units (TMR)".

The scaling parameter "Measuring units per revolution (MUPR)" — increments per revolution — indicates the resolution of the position value per revolution (also: ST-resolution). The value corresponds to 360°. That is, if a value of 3600 Cts is parametrized, the encoder outputs the position in 0.1° steps (see equation (2)).

$$MUPR = ST = 3600 \text{ Cts} \quad (1)$$

$$\text{Angular steps} = \frac{\text{Angle of one revolution}}{MUPR} = \frac{360^\circ}{3600 \text{ Cts}} = 0,1^\circ/\text{Cts} \quad (2)$$

The scaling parameter "Total measuring range in measuring units (TMR)" — the maximum total measuring range of the position value (singleturn and multiturn multiplied) — indicates the total resolution of the encoder. When the position value reaches TMR -1, it jumps back to 0 and vice versa.

As a rule, the selected TMR parameter should be an integer multiple of the "Measuring units per revolution (MUPR)" (see equation (4)), so that the zero point is always at the same position of the encoder shaft.

$$TMR = 36000 \text{ Cts} \quad (3)$$

$$MT = \frac{TMR}{MUPR} = \frac{36000 \text{ Cts}}{3600 \text{ Cts}} = 10 \quad (4)$$

In exceptional cases, it is suitable that TMR is not an integer multiple of MUPR — for example, in a system in which a gear ratio ensures that the desired measured variable is moving 10% faster relative to the encoder shaft.

In this case, a setting of MUPR = 3960 Cts and TMR = 36000 Cts would ensure that the faster (but not directly measurable) shaft can be measured with a resolution of 0.1° and over a range of 10 revolutions. Normally, the number of revolutions would be calculated by dividing the position value by MUPR. In this case, however, it must be divided by 3600 Cts, since the result would otherwise be the number of revolutions of the encoder shaft and not the faster shaft of the system.



- It should be noted that measurement errors will occur if the result of this formula is a decimal.

### 3.4 Connection assignments for EtherNet/IP encoders

#### 3.4.1 BI2 — bus cover with 3x M12x1

The string "BI2" in the order code identifies an encoder with a bus cover. The electrical connection is made on the bus cover via 2x M12 connectors and 1x M12 port. The connection assignments for the plugs and sockets are listed in Table 3.1.



Pin assignment		Pin assignment		Pin assignment	
BI2		BI2.		BI2.	
					
Port (Port1)	M12x1, 4-pole, D-coded	Connector (Power)	M12x1, 4-pole, A-coded	Port (Port2)	M12x1, 4-pole, D-coded
Tx+	1	UB+	1	Tx+	1
Rx+	2	n. c.	2	Rx+	2
Tx-	3	UB-	3	Tx-	3
Rx-	4	n. c.	4	Rx-	4

Table 3.1: Connection assignment — BI2

### 3.5 LEDs and signalling

Four status LEDs on the bus cover signal the various encoder states and thus support error diagnosis and troubleshooting in the field (see Table 3.2). The two Link Activity LEDs (L/A) light up or flash green when the encoder is connected to another Ethernet node (PLC, switch, additional field device...) and data is being exchanged. The MOD LED the status of the encoder.

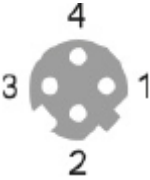
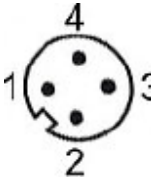
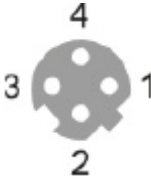
	<ul style="list-style-type: none"> <li>ATTENTION! The STAT LED is lit during operation but is negligible for the network status of the encoder.</li> </ul>
---	--

STAT LED bicolour	MOD LED bicolour	Meaning	Cause
○	○	No power	
●	✱	Standby	The device has not yet been fully configured.
●	●	Operational	The device has been fully commissioned and data exchange is taking place.
●	✱/✱	Self-test	The device is currently performing powerup testing.
●	✱	Major recoverable fault	The device has detected a major recoverable fault. (Please contact support)
●	●	Major unrecoverable fault	The device has detected a major unrecoverable fault. (Please contact support)

Table 3.2: LED signal

Explanation of symbols and asterisks:

○ LED off    ●/● LED on    ✱/✱ LED flashing

### 3.6 MAC address and IP address

Wachendorff EtherNet/IP encoders have three MAC addresses. These always start with D4-90-E0-xx-xx-xx. The number depends on the number of ports on the integrated three-port switch. There is one MAC address each for Port1 and Port2, as well as one MAC address for the "internal port" to which the encoder itself is connected.

In the delivered state, the EtherNet/IP encoder is in DHCP mode and has the name "WDGA-EP". If you want to assign a static IP address then you can define this in your project (e.g. Studio 5000) during project planning.

## 4 EtherNet/IP

### 4.1 Functions overview

Functions	Meaning
<b>Performance</b>	-Cycle time: $\leq 1\text{ms}$ -Ramp-up time: $< 1\text{s}$
<b>Webserver</b>	Display and setting of parameters, as well as firmware updates
<b>Process data</b>	Cyclic up to 20 bytes
<b>Profile</b>	Encoder Device Profile: Device Type 22h

Table 4.1: Functions

### 4.2 List of all classes

Code	Class	Instance
<b>01h</b>	Identity	1
<b>02h</b>	Message Router	1
<b>04h</b>	Assembly	6
<b>06h</b>	Connection Manager	1
<b>23h</b>	Position Sensor Object	1
<b>47h</b>	Device Level Ring	1
<b>48h</b>	QoS	1
<b>F5h</b>	TCP/IP Interface	1
<b>F6h</b>	Ethernet Link	3

Table 4.2: List of all classes

### 4.3 Process and configuration data

In an EtherNet/IP network, the process data can be read out either via the assembly object or by "Explicite Messaging" of the "Position Sensor Object".

The assemblies are predefined and fixed by the manufacturer and/or the specification. They cannot be changed by the user, so they contain only selected cyclic process data. With the "Position Sensor Object" it is possible to access all process data acyclically.

#### 4.3.1 Process data overview (Assemblies)

The following table lists the available assemblies. You can find a detailed description in 4.3.2 bis 4.3.7.

Instance nr.	Meaning
<b>1</b>	Position
<b>2</b>	Position + State
<b>3</b>	Position + Velocity
<b>100</b>	Position + Velocity + Position State + CAM State + Status
<b>101</b>	Position64 + Velocity + Position State + CAM State + Status
<b>101 + 110</b>	101: Position64 + Velocity + Position State + CAM State + Status  Config (110): Preset + MUPR + TMR + Gear ratio multiplier + Gear ratio divisor + Velocity Format + Direction Counting Toggle + Scaling enable + Preset execute

Table 4.3: Process data overview

### 4.3.2 Process data Assembly 1

This assembly contains the position value. It also has a width of 32 bits. The position value is unsigned.

Instance	Signal									Description
	Byte	Bit: 0	Bit: 1	Bit: 2	Bit: 3	Bit: 4	Bit: 5	Bit: 6	Bit: 7	
1	0	Position LSB							Position value (scaled). The position value calculation is influenced by the following functions, among others: MUPR, TMR, scaling function, offset, preset, gear ratio if applicable.	
	1	Position								
	2	Position								
	3	Position MSB								

Table 4.4: Assembly 1



### 4.3.3 Process data Assembly 2

This assembly contains the position value and a status display. It also has a width of 40 bits. The position value is unsigned.

Instance	Signal									Description
	Byte	Bit: 0	Bit: 1	Bit: 2	Bit: 3	Bit: 4	Bit: 5	Bit: 6	Bit: 7	
2	0	Position LSB								Position value (scaled). The position value calculation is influenced by the following functions, among others: MUPR, TMR, scaling function, offset, preset, gear ratio if applicable.
	1	Position								
	2	Position								
	3	Position MSB								
	4	Alarm Flag	Warning Flag	x	x	x	x	x	x	0 if there are no warnings or alarms, otherwise correspondingly 1

Table 4.5: Assembly 2

### 4.3.4 Process data Assembly 3

This assembly contains the position value and the velocity. It also has a width of 64 bits. The position value is unsigned, but the velocity value is signed.

Instance	Signal									Description
	Byte	Bit: 0	Bit: 1	Bit: 2	Bit: 3	Bit: 4	Bit: 5	Bit: 6	Bit: 7	
3	0	Position LSB							Position value (scaled). The position value calculation is influenced by the following functions, among others: MUPR, TMR, scaling function, offset, preset, gear ratio if applicable.	
	1	Position								
	2	Position								
	3	Position MSB								
	4	Velocity LSB							Velocity value. The velocity value is influenced by the following functions, among others: Velocity Format, Velocity Resolution	
	5	Velocity								
	6	Velocity								
	7	Velocity MSB								

Table 4.6: Assembly 3

### 4.3.5 Process data Assembly 100

This assembly contains the position value, the speed, a position status register, a CAM status register and a status display. It also has a width of 88 bits. The position value is not signed, but the velocity value is.

Instance	Signal									Description
	Byte	Bit: 0	Bit: 1	Bit: 2	Bit: 3	Bit: 4	Bit: 5	Bit: 6	Bit: 7	
100	0	Position LSB							Position value (scaled). The position value calculation is influenced by the following functions, among others: MUPR, TMR, scaling function, offset, preset, gear ratio if applicable.	
	1	Position								
	2	Position								
	3	Position MSB								
	4	Velocity LSB							Velocity value. The velocity value is influenced by the following functions, among others: Velocity Format, Velocity Resolution	
	5	Velocity								
	6	Velocity								
	7	Velocity MSB								
	8	Position State register							Software end positions switch. 0 if within the defined limit range, otherwise correspondingly 1	
	9	CAM state register							Software camshafts. 0 if within the defined limit range, otherwise correspondingly 1	
10	Status							See Table 4.8		

Table 4.7: Assembly 100

### 4.3.6 Process data Assembly 101

This assembly contains the position value (64-bit), the speed, a position status register, a CAM state register and a status display. It also has a width of 120 bits. The position value is not signed, but the velocity value is.

Instance	Signal									Description	
	Byte	Bit: 0	Bit: 1	Bit: 2	Bit: 3	Bit: 4	Bit: 5	Bit: 6	Bit: 7		
101	0	Position64 LSB									Position value 64-Bit (scaled). The position value calculation is influenced by the following functions, among others: MUPR, TMR, scaling function, offset, preset, gear ratio if applicable.
	1	Position64									
	2	Position64									
	3	Position64									
	4	Position64									
	5	Position64									
	6	Position64									
	7	Position64 MSB									
	8	Velocity LSB									Velocity value. The velocity value is influenced by the following functions, among others: Velocity Format, Velocity Resolution
	9	Velocity									
	10	Velocity									
	11	Velocity MSB									
	12	Position State register									Software end positions switch. 0 if within the defined limit range, otherwise correspondingly 1
13	CAM State register									Software camshafts. 0 if within the defined limit range, otherwise correspondingly 1	

	14	Status	<p>Signals the status of the encoder:</p> <p>0000: Self test          0001: FW update in progress          0010: Min. one connection error          0011: No connection          0100: Configuration error          0101: Major fault          0110: Min. one connection in run          0111: Min. one connection, all in idle          1000: reserved          1001: reserved          1111: Sensor error</p>
--	----	--------	---

Table 4.8: Assembly 101

### 4.3.7 Configuration Assembly 110

This assembly contains the preset, the MUPR, the TMR, the gear ratio, the speed format and in the last byte the direction change, the scaling and the preset (execute). It also has a width of 224 bits.

Instance	Signal									Description
	Byte	Bit: 0	Bit: 1	Bit: 2	Bit: 3	Bit: 4	Bit: 5	Bit: 6	Bit: 7	
101	0	Preset LSB							Preset. The preset sets the position value to a fixed value. Will only be executed if Preset Execute = 1.	
	1	Preset								
	2	Preset								
	3	Preset								
	4	Preset								
	5	Preset								
	6	Preset								
	7	Preset MSB								
	8	MUPR LSB							Measuring units per revolution. The MUPR defines with how many increments one revolution of 360° of the encoder shaft is resolved.	
	9	MUPR								
	10	MUPR								
	11	MUPR MSB							Total Measuring Range. The TMR defines the total measuring range of the encoder, i.e. after how many increments the position value rolls over to 0.	
	12	TMR LSB								
	13	TMR								
	14	TMR								
15	TMR									

	16	TMR							
	17	TMR							
	18	TMR							
	19	TMR MSB							
	20	Gear Ratio Multiplier LSB						Here the size of the encoder gear is set.	
	21	Gear Ratio Multiplier MSB							
	22	Gear Ratio Divisor LSB						Here the size of the main gear is set.	
	23	Gear Ratio Divisor MSB							
	24	Velocity Format LSB						Sets the format of the position value. 1F04h: Counts per second (default). 1F05h: Counts per ms 1F07h: Counts per minute 1F0Fh: Revolutions per minute	
	25	Velocity Format MSB							
26	Direction Counting Toggle	Scaling enable	Preset execute	x	x	x	x	x	Bit 0: Direction counting toggle defines the counting direction of the position value.  Bit 1: Scaling enable determines whether scaling is on or off.  Bit 2: Preset execute defines whether a preset is executed or not.
27	reserved								

Table 4.9: Config Assembly 110





## 4.4 Class attributes

Here you can find a detailed listing of the classes 01h and 23h.

### 4.4.1 Identity Object 01h

The Identity Object provides general information about the device such as identification, status, etc.

Attr. -ID	Name	Data type	Access	Description
1	Vendor ID	UINT	R	Specifies the vendor ID of the manufacturer.
2	Device Type	UINT	R	Specifies the type of the device.
3	Product Code	UINT	R	Used to identify the device to the manufacturer.
4	Revision	USINT	R	Revision number of the device.
5	Status	WORD	R	Represents the current status of the device.  0000b: Self test 0001b: FW update in progress 0010b: Min. one connection error 0011b: No connection 0100b: Configuration error 0101b: Major fault 0110b: Min. one connection in run 0111b: Min. one connection, all in idle 1000b: reserved 1001b: reserved 1111b: Sensor fault
6	Serial Number	UDINT	R	The serial number of the device.
7	Product Name	STRING	R	Product name as ASCII string.
8	State	USINT	R	Current state of the device.  0: Non-existent 1: Self test 2: Standby 3: Ready for operation 4: Major Recoverable Fault 5: Major Unrecoverable Fault

Table 4.10: Identity Object

## 4.4.2 Position Sensor Object 23h

The Position Sensor Object provides all process data of the encoder.

Attr.-ID	Name	Data type	Access	Description
1	Number of Attributes	USINT	R	Represents the number of attributes implemented in the Position Sensor Object.
2	Attribute List	Array of USINT	R	Outputs all implemented attributes as a list.
3	Position Value unsigned	UDINT	R	Indicates the position value of the encoder (see Table 4.4: Assembly 1).
11	Position Sensor Type	UINT	R	Indicates which type the position sensor has.  01h = Absolute singleturn encoder  02h = Absolute multiturn encoder
12	Direction Counting Toggle	BOOL	RW	Defines the counting direction of the position value with view to the encoder shaft.  0 = positive counting direction of the position value with clockwise shaft rotation.  1 = positive counting direction with counterclockwise shaft rotation.
14	Scaling Function Control	BOOL	RW	The scaling of the encoder can be switched on or off herewith.  If 0: Position value (attr. 3) = physical resolution of the encoder.  If 1: Position value (attr. 3) = (physical resolution of the encoder) * (MUPR (attr. 16) / Physical Resolution Span (attr. 42))
16	Measuring Units per span	UDINT	RW	See: Table 4.9
17	Total Measuring Range in Measuring Units	UDINT	RW	See: Table 4.9

<b>19</b>	Preset Value	UDINT	RW	<p>The preset value is subject to scaling, it can be reset again and again.</p> <p>Default: 0</p> <p>If the preset is executed, then the following applies to the offset: Offset value (attr. 51) = Preset value - Position value</p>
<b>21</b>	Position State register	USINT	R	<p>The Position State Register serves as a software defined limit switch.</p> <p>Bit 0 = 1 Out of Range Bit 1 = 1 Range overflow Bit 2 = 1 Range underflow</p>
<b>22</b>	Position Low Limit	DINT	RW	<p>Lower limit of the end position. Is compared with the position value. If the value falls below the limit, the status can be read out via attribute 21.</p>
<b>23</b>	Position High Limit	DINT	RW	<p>Upper limit of the end position. Is compared with the position value; if exceeded, the status can be read out via attribute 21.</p>
<b>24</b>	Velocity value	DINT	R	See: Table 4.6
<b>25</b>	Velocity format	ENGUINT	RW	See: Table 4.9Table 4.6
<b>26</b>	Velocity resolution	UDINT	RW	The resolution of the velocity value is defined in steps of 0.01mm/s.
<b>41</b>	Operating Status	USINT	R	<p>Indicates the operating status of the encoder:</p> <p>Bit 0: Direction False (0) = Increasing True (1) = Decreasing</p> <p>Bit 1: Scaling False (0) = Off True (1) = ON</p>
<b>42</b>	Physical Resolution Span	UDINT	R	<p>The maximum number of steps per revolution is shown here.</p> <p>= 10000h</p>
<b>43</b>	Number of spans	UINT	R	<p>Specifies how many revolutions can be measured.</p> <p>ST = 1 MT = FFFFh</p>

<b>44</b>	Alarms	WORD	R	<p>An alarm is set when a malfunction bit is set to true. The alarm remains active until it is cleared, and the device is able to operate correctly again.</p> <p>Bit 0: Position Error Bit 1: Diagnostic Error Bit 2...11: reserved Bit 12...15: manufacturer specific</p>
<b>45</b>	Supported Alarms	WORD	R	<p>Contains the information about the supported alarms of the device.</p> <p>Bit 0: Position Error Bit 1: Diagnostic Error Bit 2...11: reserved Bit 12...15: manufacturer specific</p>
<b>46</b>	Alarm Flag	BOOL	R	<p>The flag indicates whether an alarm error has occurred. It corresponds to a logical OR of all alarm bits of attribute 44</p>
<b>47</b>	Warnings	WORD	R	<p>The warnings indicate when certain parameters of the device are not adhered to or when limit values are exceeded. All warnings are deleted as soon as the parameters are back in the normal range.</p> <p>Bit 0: Frequency exceeded Bit 10: Position Limits exceeded Bit 11...12: reserved Bit 13...15: manufacturer-specific</p>
<b>48</b>	Supported Warnings	WORD	R	<p>This attribute contains information about the supported warnings of the device.</p> <p>Bit 0: Frequency Exceeded Bit 10: Position Limits Exceeded Bit 11...12: reserved Bit 13...15: manufacturer specific</p>
<b>49</b>	Warning Flag	BOOL	R	<p>This flag signals when a warning error has occurred. It corresponds to a logical OR of all alarm bits of attribute 47.</p>

<b>50</b>	Operating Time	UDINT	R	Incremented at power-up. Subsequently, the value increases by 1 every 6 minutes.
<b>51</b>	Offset Value	DINT	R	The preset function shifts part of the position value to the offset. The offset value is automatically stored in the device and can be used for diagnostics.  Offset value = Preset Value - Position Value
<b>100</b>	Position 64-Bit	ULINT	R	See Table 4.8
<b>101</b>	Raw Position	ULINT	R	Raw position value of the encoder.
<b>102</b>	TMR 64-Bit	ULINT	RW	See Table 4.9
<b>103</b>	Preset 64-Bit	LINT	RW	See Table 4.9
<b>104</b>	Offset 64-Bit	LINT	R	See attribute 51
<b>105</b>	Hysteresis Position	SINT	RW	Size of the hysteresis for the position value  Value range: 0...255 Default: 04h
<b>106</b>	Filter Position	SINT	RW	Number of average values for the position value.  Value range: 0...255
<b>107</b>	Gear Multiplier	WORD	RW	The two parameters gear ratio numerator and denominator can be used to adjust the position value to take into account an existing gear.  -The total resolution for this function is limited to 20 bits (max. 1,048,576 steps).  -The revolution resolution has no relevance for this function, the 16-bit raw resolution is always used.  Example rotary table: Gear encoder: 12 teeth Driven rotary table: 250 teeth  One revolution of the rotary table should be mapped to 100000 steps. If the driven rotary table rotates once, then the encoder shaft
<b>108</b>	Gear Divisor	WORD	RW	

				<p>rotates by 250/12, i.e. 20.8333 times.</p> <p>The following setting must be selected here:</p> <p>Gear ratio numerator: 12 Gear ratio denominator: 250 Total resolution: 100000</p>
<b>109</b>	Position Low Limit 64-Bit	LINT	RW	See attribute 22
<b>110</b>	Position High Limit 64-Bit	LINT	RW	See attribute 23
<b>111</b>	Frequency Limit	WORD	RW	The frequency of rotation can be set via the Frequency Limit. This influences attribute 47 (Warnings).
<b>112</b>	Sensor Error	WORD	R	
<b>113</b>	CAM state register	USINT	R	The CAM-state-register serves for the representation of the cam switching states in dependence on the position of the encoder shaft. For this purpose, the value of the register must be broken down in binary notation (see below). Each bit of the octet shows the status of a certain switching position. See 4.4.2.1
<b>114</b>	CAM enable register	USINT	RW	Each cam switch position of the CAM channel in the encoder must be "switched on" individually for use. The "switching on" of the individual CAM works by writing the appropriate value into the attribute. The correct value can be found by setting the bit to 1 in binary notation for each cam switch position that is to be active. See 4.4.2.2
<b>115</b>	CAM polarity register	USINT	RW	The CAM Polarity register can be used to change the polarities of each cam switch position in the CAM channel. By default, the polarity is set so that all cam positions "jump" to High (= 1b) at position values in their limits. By changing the individual bits, the

				individual polarities of the cam positions can be changed. Thus, for a value of 13h (= 0110 0100b), CAM 3, CAM 6 and CAM 7 are inverted when position value within limits. See 4.4.2.3
<b>116</b>	CAM low limits 1	LINT	RW	The CAM low limit defines the lower switching point of a cam switch position. Each individual cam position has its own CAM low limit attribute. See 4.4.2.4
<b>117</b>	CAM low limits 2	LINT	RW	See above
<b>118</b>	CAM low limits 3	LINT	RW	See above
<b>119</b>	CAM low limits 4	LINT	RW	See above
<b>120</b>	CAM low limits 5	LINT	RW	See above
<b>121</b>	CAM low limits 6	LINT	RW	See above
<b>122</b>	CAM low limits 7	LINT	RW	See above
<b>123</b>	CAM low limits 8	LINT	RW	See above
<b>124</b>	CAM high limits 1	LINT	RW	The CAM high limit defines the upper switching point of a cam switch position. Each individual cam position has its own high limit attribute. See 4.4.2.5
<b>125</b>	CAM high limits 2	LINT	RW	See above
<b>126</b>	CAM high limits 3	LINT	RW	See above
<b>127</b>	CAM high limits 4	LINT	RW	See above
<b>128</b>	CAM high limits 5	LINT	RW	See above
<b>129</b>	CAM high limits 6	LINT	RW	See above
<b>130</b>	CAM high limits 7	LINT	RW	See above
<b>131</b>	CAM high limits 8	LINT	RW	See above
<b>132</b>	CAM hysteresis 1	UINT	RW	The width of the hysteresis of the switchover points is defined via the CAM hysteresis. For each individual cam switch position a separate CAM hysteresis can be set. See 4.4.2.6
<b>133</b>	CAM hysteresis 2	UINT	RW	See above
<b>134</b>	CAM hysteresis 3	UINT	RW	See above
<b>135</b>	CAM hysteresis 4	UINT	RW	See above
<b>136</b>	CAM hysteresis 5	UINT	RW	See above
<b>137</b>	CAM hysteresis 6	UINT	RW	See above
<b>138</b>	CAM hysteresis 7	UINT	RW	See above
<b>139</b>	CAM hysteresis 8	UINT	RW	See above
<b>140</b>	Preset execute	BOOL	RW	If the preset value has been set once in attribute 19, then you can execute the preset again via

				attribute 140 "Preset execute" without having to assign a new value. The value automatically resets to 0.
--	--	--	--	---

Table 4.11: Position Sensor Object

#### 4.4.2.1 113d– CAM state register

The CAM-state-register (attribute 113d) is used to represent the cam switching states depending on the position of the encoder shaft. For this purpose, the value of the register must be broken down in binary notation (see below). Each bit of the octet from attribute 113 shows the status of a specific switching position.

The following example shows a CAM-state-register with the value 89h:

Position	7(MSB)	6	5	4	3	2	1	0(LSB)
Type	CAM 8	CAM 7	CAM 6	CAM 5	CAM 4	CAM 3	CAM 2	CAM 1
Value	1	0	0	0	1	0	0	1
Logic	High	Low	Low	Low	High	Low	Low	High

Table 4.12: CAM state register



As can be seen above, the value 89h defines that the cam positions CAM 1, CAM 4 and CAM 8 are High and the remaining cams are Low. If the shaft continues to rotate, it could happen, for example, that CAM 4 finally becomes Low as well. Then the value of the CAM-state-register = 81h:

Position	7(MSB)	6	5	4	3	2	1	0(LSB)
Type	CAM 8	CAM 7	CAM 6	CAM 5	CAM 4	CAM 3	CAM 2	CAM 1
Value	1	0	0	0	0	0	0	1
Logic	High	Low	Low	Low	Low	Low	Low	High

Table 4.13: CAM state register

By switching each CAM independently, 256 different states can thus be generated within one attribute, which can be used to control machines.

#### 4.4.2.2 114d – CAM enable register

Each cam position of the CAM channel in the encoder must be "switched on" individually for use. The "switching on" of the individual CAM works by writing the appropriate value into attribute 114d. The correct value is to be found by setting the bit to 1 in binary notation for each cam switch position that is to be active. For example, if only CAM 2, CAM 4 and CAM 7 are to be active, the result after binary notation is:

Position	7(MSB)	6	5	4	3	2	1	0(LSB)
Type	CAM 8	CAM 7	CAM 6	CAM 5	CAM 4	CAM 3	CAM 2	CAM 1
Value	0	1	0	0	1	0	1	0

Table 4.14: CAM enable register

This corresponds to the value 4Ah.

#### 4.4.2.3 115d – CAM polarity register

The CAM-polarity-register in attribute 115 can be used to change the polarities of each cam switch position in the CAM channel. By default the polarity is set so that all cam positions "jump" to High (= 1b) at position values in their limits (default = 000000b = 00h). By changing the individual bits, the individual polarities of the cam positions can be changed. Thus, at a value of 13h (= 00010011b) CAM 1, CAM 2 and CAM 5 are inverted (bit = 0b (Low), if position value within the limits).

Position	7(MSB)	6	5	4	3	2	1	0(LSB)
Type	CAM 8	CAM 7	CAM 6	CAM 5	CAM 4	CAM 3	CAM 2	CAM 1
Value	0	0	0	1	0	0	1	1
Logic	Default	Default	Default	Inverted	Default	Default	Inverted	Inverted

Table 4.15: CAM polarity register

#### 4.4.2.4 116d...123d – CAM1...CAM8 low limit

The CAM-Low-Limit defines the lower switching point of a cam switch position. Each individual cam switch position (CAM 1 ... CAM 8) has its own CAM Low Limit attribute (see attributes 116d - 123d).

#### 4.4.2.5 124d...131d– CAM1...CAM8 high limit

The CAM High Limit defines the upper switching point of a cam switch position. Each individual cam switch position (CAM 1 ... CAM 8) has its own CAM High Limit object (see attributes 124d - 131d).

#### 4.4.2.6 132d...139d – CAM1...CAM8 hysteresis

The width of the hysteresis of the switch-over points is defined via the CAM hysteresis. For each individual cam switch position (CAM 1 ... CAM 8) a separate CAM hysteresis can be set (see attributes 132d - 139d).

## 5 Webserver

### 5.1 General

The EtherNet/IP encoders have a web server where you can view or set some information and configurations. To access the web server, call up its IP address using a browser of your choice (Microsoft Edge, Firefox, etc.). To do this, connect the encoder to your computer via an Ethernet cable (M12 connector on the encoder and RJ45 connector on the PC). Make sure that your PC is in the same IP address range as the encoder.



- Example configuration:  
IP address of the encoder: 192.168.0.1  
IP address of the PC: 192.168.0.100  
Subnet address of the PC: 255.255.255.0

Once you have done this, the start page (Information - Overview) of the encoder opens.



In the following subchapters we will show you the different views of the web server and explain the possible functions.

## 5.2 Information

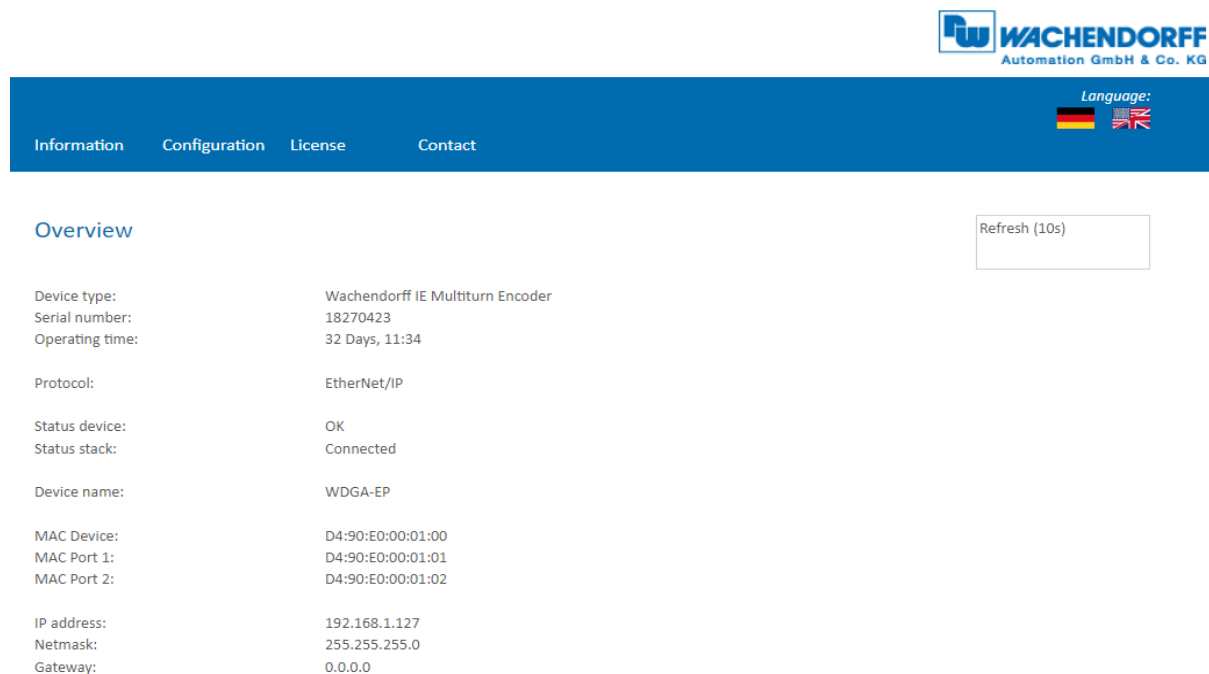
### 5.2.1 Overview



**WACHENDORFF**  
Automation GmbH & Co. KG

Language:  

Information Configuration License Contact

Overview Refresh (10s)

Device type:	Wachendorff IE Multiturn Encoder
Serial number:	18270423
Operating time:	32 Days, 11:34
Protocol:	EtherNet/IP
Status device:	OK
Status stack:	Connected
Device name:	WDGA-EP
MAC Device:	D4:90:E0:00:01:00
MAC Port 1:	D4:90:E0:00:01:01
MAC Port 2:	D4:90:E0:00:01:02
IP address:	192.168.1.127
Netmask:	255.255.255.0
Gateway:	0.0.0.0

Figure 5.1: Overview

In the overview you will find the following information:

- Device type: designation of the encoder
- Serial number: Device number of the encoder
- Operating time in hours: Number of hours in running operation
- Protocol: EtherNet/IP
- Device status: On or Off state
- Stack status: Connected or Offline
- Device name: WDGA-EP
- MAC device: MAC address of the encoder
- MAC port 1: MAC address of Ethernet port 1
- MAC port 2: MAC address of Ethernet port 2
- IP address: IP address of your EtherNet/IP encoder
- Netmask: Subnet mask of your EtherNet/IP encoder
- Gateway: Gateway of your EtherNet/IP encoder

The refresh rate of the web page is fixed at 10 seconds and cannot be changed. You can tell that the data is being updated by the message: "Refreshing data", at the top right of the field where the refresh time is displayed.

You can switch the language of the web server after the call.

After switching in a sub-mask, the web server starts again in the start mask.

## 5.2.2 Versions



### Versions

Application:	1.02.00.456
SDAI:	1.91.00.16820
Stack:	2.13.00.16820
MAC:	1.62.00.16820
Sensor:	1.16 (13)
U2A:	4.00.00.0

Figure 5.2: Versions

Here you can find the information of each version status like:

- Applikation
- SDAI
- Stack
- MAC
- Sensor
- U2A

## 5.3 Configuration

### 5.3.1 Network

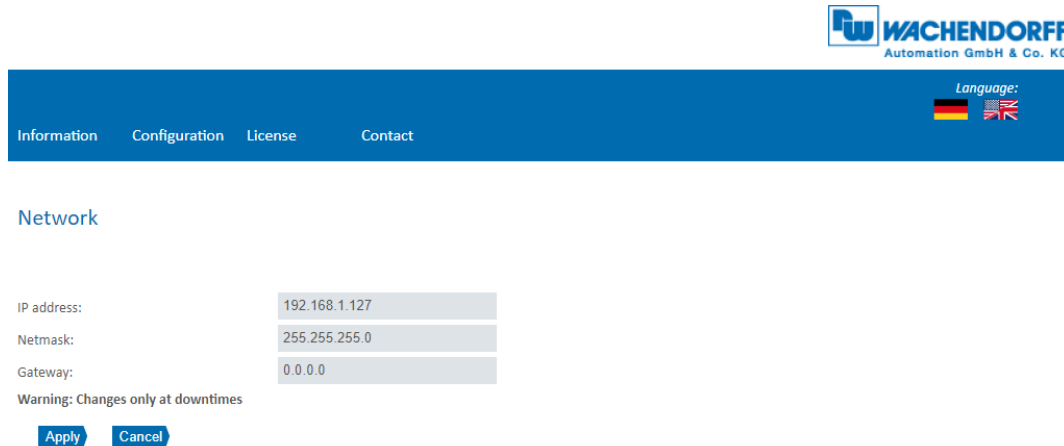

The screenshot shows the 'Network' configuration page. At the top right, there is a 'Language:' dropdown menu with flags for German and English. Below this is a navigation bar with 'Information', 'Configuration', 'License', and 'Contact' tabs. The main content area is titled 'Network' and contains the following fields:

IP address:	192.168.1.127
Netmask:	255.255.255.0
Gateway:	0.0.0.0

Warning: Changes only at downtimes

Buttons: Apply, Cancel

Figure 5.3: Network

Here you can change the device name, IP address, network mask and gateway.

	<ul style="list-style-type: none"><li>• Please make sure that you only change the data when the plant is shut down.</li></ul>
---	---

### 5.3.2 Encoder

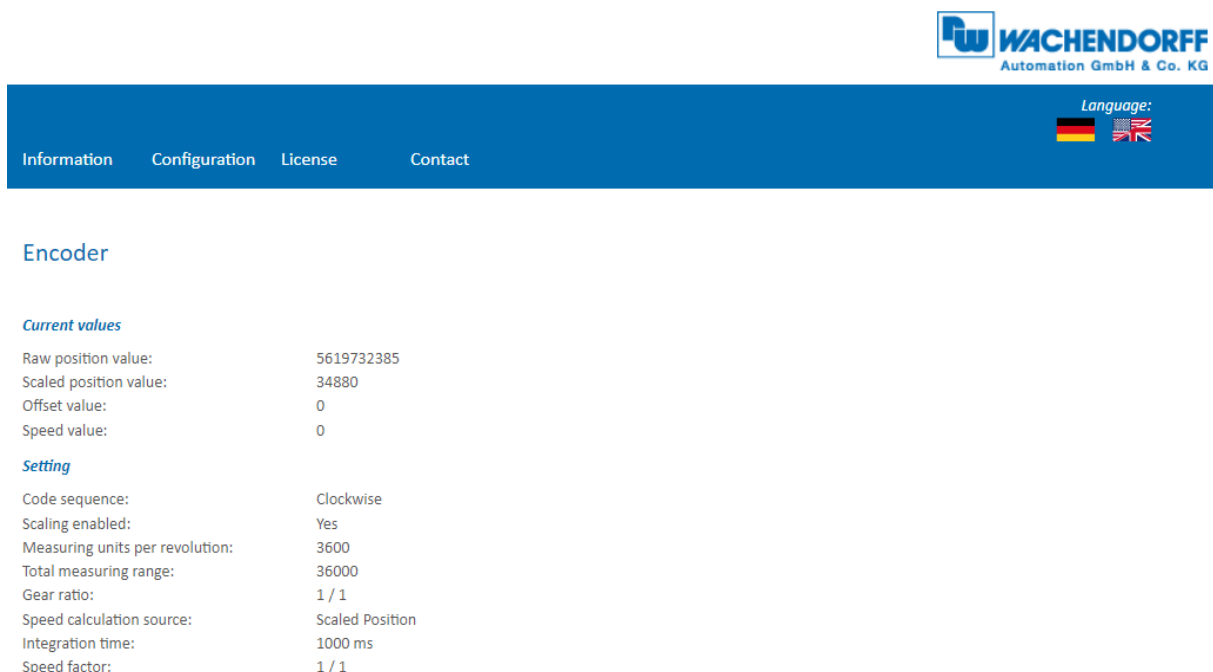

The screenshot shows the 'Encoder' configuration page. At the top right, there is a 'Language:' dropdown menu with flags for German and English. Below this is a navigation bar with 'Information', 'Configuration', 'License', and 'Contact' tabs. The main content area is titled 'Encoder' and contains the following sections:

**Current values**

Raw position value:	5619732385
Scaled position value:	34880
Offset value:	0
Speed value:	0

**Setting**

Code sequence:	Clockwise
Scaling enabled:	Yes
Measuring units per revolution:	3600
Total measuring range:	36000
Gear ratio:	1 / 1
Speed calculation source:	Scaled Position
Integration time:	1000 ms
Speed factor:	1 / 1

Figure 5.4: Encoder

Here you can check the following parameterized values of the encoder:

- Raw position value
- Scaled position value
- Offset
- Velocity value
- Code sequence (Direction of rotation)
- Scaling enabled (Yes/no)
- Measuring units per revolution (MUPR)
- Total measuring range (TMR)
- Gear ratio
- Speed calculation source
- Integration time
- Speed factor

### 5.3.3 Firmware Update

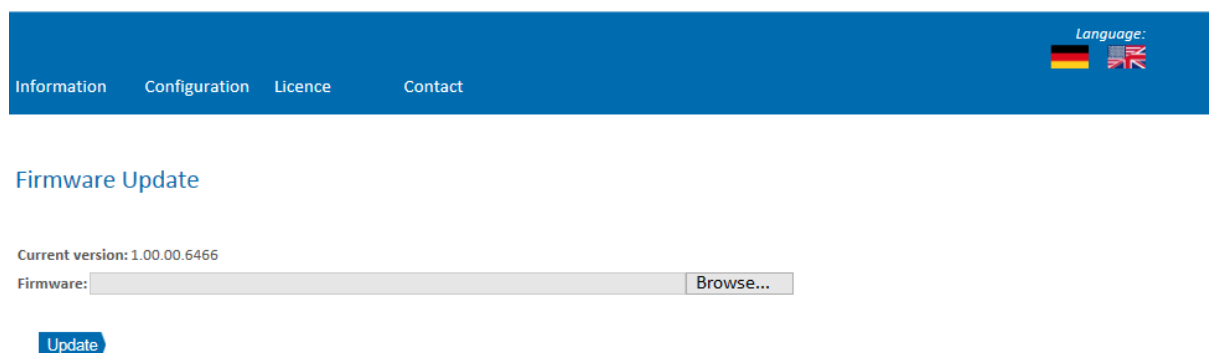



Figure 5.5: Firmware update

The current firmware version of the encoder is displayed. If a new firmware version is available, you can update the encoder's firmware here.

	<ul style="list-style-type: none"><li>• Please take care that you do not execute the firmware update while a configured connection to a PLC exists.</li><li>• Do not cut off the power supply or disconnect the network cable while performing a firmware update.</li></ul>
---	---

To update the firmware of the encoder, choose the correct .bin file by clicking the "Browse..."-Button (see Figure 5.6: Firmware update - choose file).

Information Configuration Licence Contact

Language:  

## Firmware Update

Current version: 1.00.00.6466

Firmware:

Figure 5.6: Firmware update - choose file



After you have chosen the correct file, click the “Update”- Button to start the firmware update. An animated icon will appear with the additional text: “Transferring file” (see Figure 5.7).



Figure 5.7: Firmware update - Transferring file

After the firmware update is successfully finished, you will see it on the website like in Figure 5.8. Perform now a power reset and check under “Information -> Versions”, if the new firmware version is shown.



Figure 5.8: Firmware update - Successful

In case of a failure during the firmware update process (see Figure 5.9) please double check that you choose the correct firmware file. Do a power reset and repeat the whole firmware update process. In case of a power loss during the update, the encoder may not respond to any request anymore. If this happens, please contact our support team.

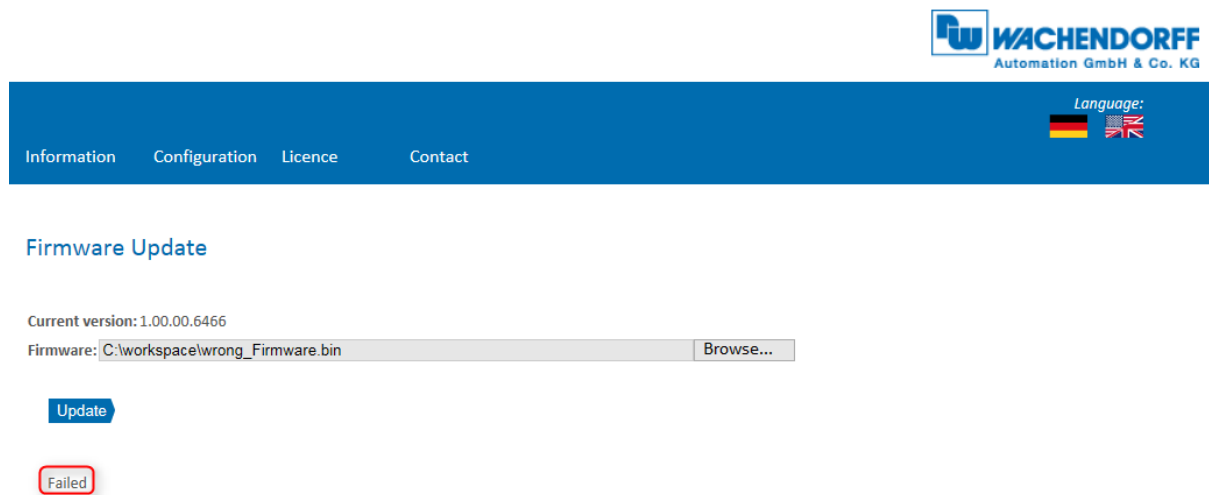

Figure 5.9: Firmware update - Failed

## 5.4 Licence information

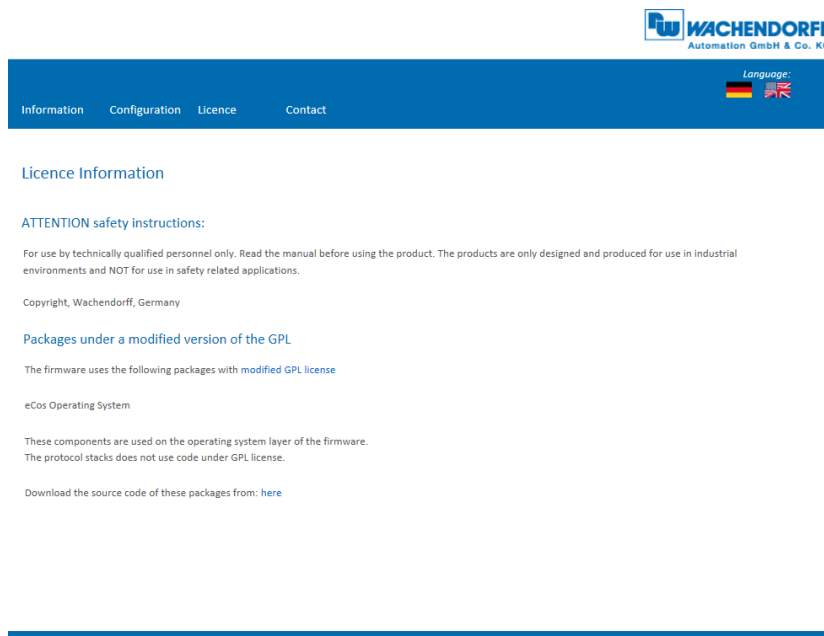
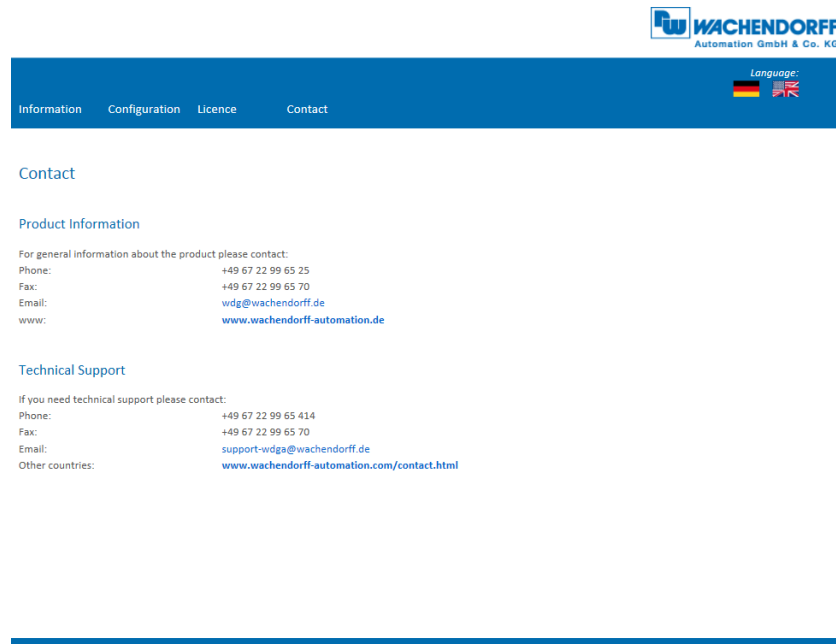

Figure 5.10: Licence information



This view contains the current safety instructions as well as software packages containing firmware. You can download the source code of these packages using the link on this website.

## 5.5 Contact



The screenshot shows the contact page of the WACHENDORFF webserver. At the top right, there is a logo for WACHENDORFF Automation GmbH & Co. KG and a language selection menu with flags for German and English. Below the logo is a navigation bar with links for Information, Configuration, Licence, and Contact. The main content area is titled 'Contact' and is divided into two sections: 'Product Information' and 'Technical Support'. The 'Product Information' section provides contact details for general product information, including phone, fax, email, and website. The 'Technical Support' section provides contact details for technical support, including phone, fax, email, and website. A thick blue horizontal line is positioned below the contact information.

**WACHENDORFF**  
Automation GmbH & Co. KG

Language:  

Information Configuration Licence Contact

### Contact

#### Product Information

For general information about the product please contact:

Phone: +49 67 22 99 65 25  
Fax: +49 67 22 99 65 70  
Email: [wdg@wachendorff.de](mailto:wdg@wachendorff.de)  
www: [www.wachendorff-automation.de](http://www.wachendorff-automation.de)

#### Technical Support

If you need technical support please contact:

Phone: +49 67 22 99 65 414  
Fax: +49 67 22 99 65 70  
Email: [support-wdga@wachendorff.de](mailto:support-wdga@wachendorff.de)  
Other countries: [www.wachendorff-automation.com/contact.html](http://www.wachendorff-automation.com/contact.html)

Figure 5.11: Contact information

Contact information for additional product information and technical support is listed here.

## 6 Commissioning

### 6.1 General

This chapter shows a configuration example of the Wachendorff EtherNet/IP encoder. The example is carried out with the Rockwell Studio 5000 software (Ver. 32.00). The device is in DHCP mode by default, we recommend to perform the commissioning with the tools installed in the course of Studio 5000.



- If you have converted a Universal Industrial Ethernet Encoder into an EtherNet/IP device, then the device is not in DHCP mode, but has a fixed IP address (default: 192.168.1.127).

### 6.2 Deactivating DHCP mode and assigning an IP address

If you have not done so yet, then you should now first of all install Studio 5000 with all additional components.

On a free Ethernet network card, you should set a static IP address. A setting in the address range 192.168.1.XXX is recommended, because the default IP address of the encoder is also in this address range (192.168.1.127).

If you have done this, start the tool "BootP DHCP EtherNet/IP Commissioning Tool", which was installed during the Studio 5000 installation. Now select the previously selected network card. After a short waiting time the encoder will appear in the upper window.

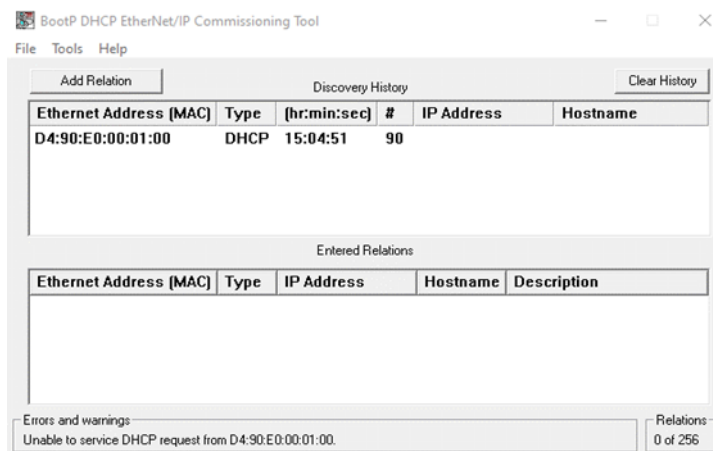



Figure 6.1: BootP-DHCP-Tool



- Beforehand check under "Tools" -> "Network Settings" that your network card is configured correctly.

Now click with the right mouse button on the device and select "add relation". A new window will appear where you can assign a static IP address and a name for the device.

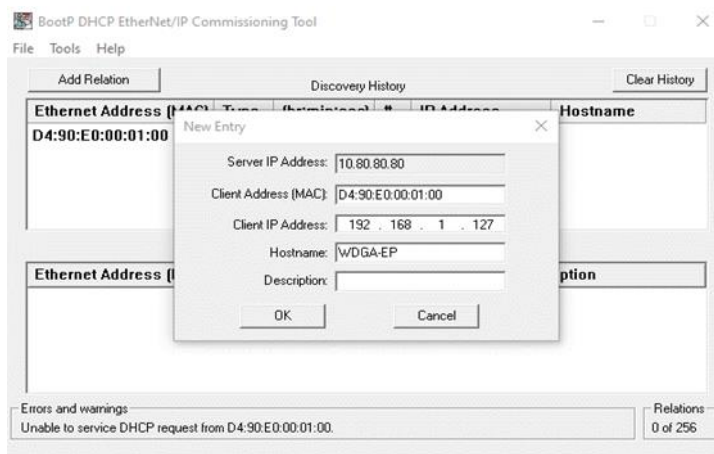

Figure 6.2: Set IP address and device name

If the IP address was assigned successfully, then a confirmation appears in the Errors and Warnings window.

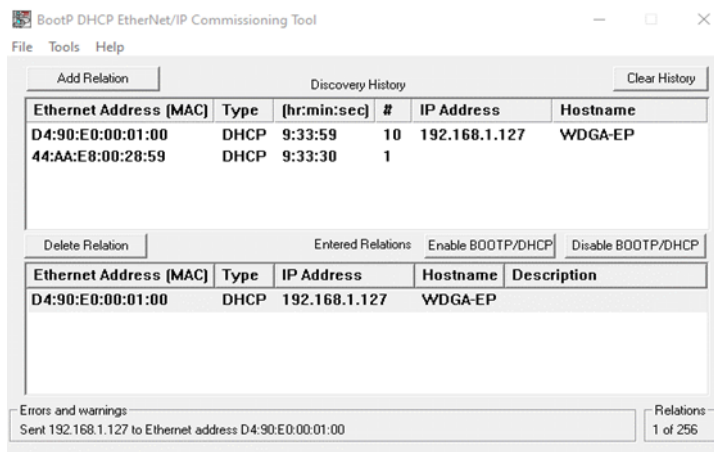

Figure 6.3: IP address and device name successfully set

Then select your device in the lower window and click on "Disable BOOTP/DHCP". If the command was executed successfully, a confirmation will again appear under "Errors and Warnings".

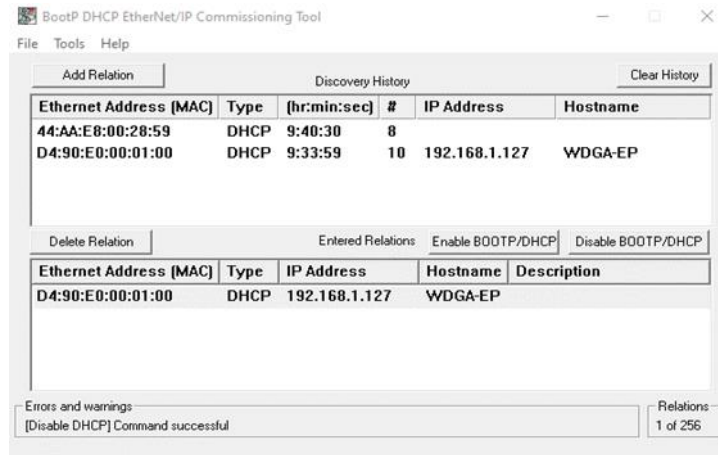

Figure 6.4: DHCP deactivated

Now use a browser of your choice and check if the web server is reachable.

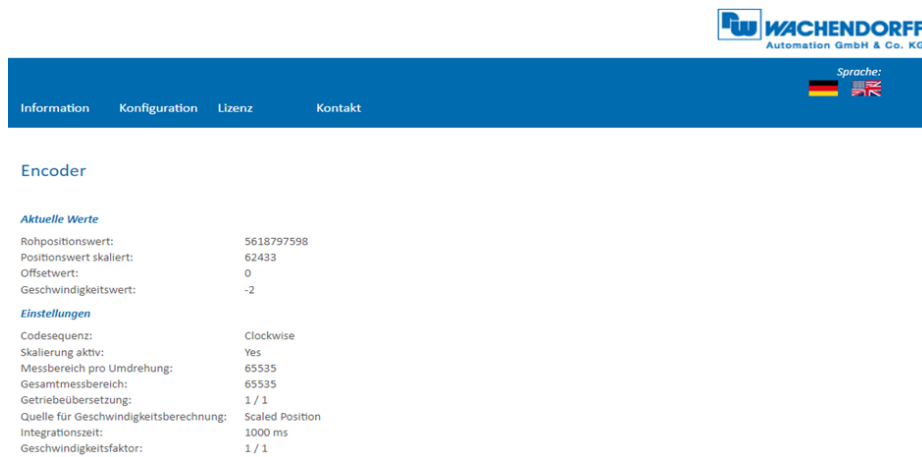

Figure 6.5: Webserver available

### 6.3 Activating DHCP mode

If you want to reset the device to DHCP mode, start the tool "BootP DHCP EtherNet/IP Commissioning Tool" again. Now click on "add relation". Add the device, for this you need to know the MAC and IP address of the device. The MAC address can be found on the label of the device.

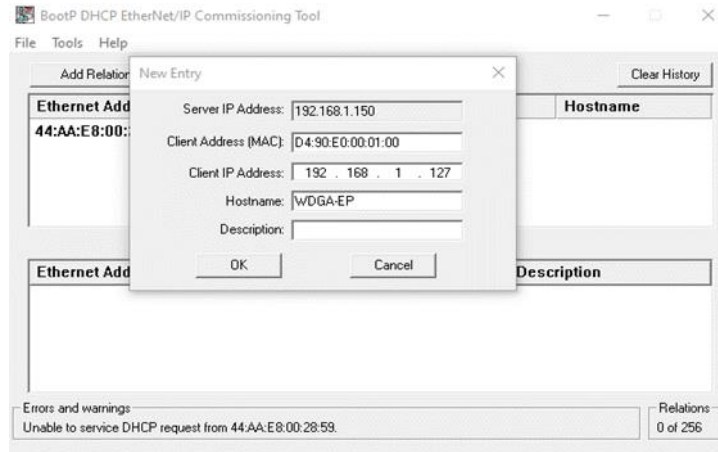

Figure 6.6: Set MAC and IP address

After you have added the device, select it and click on "Enable BOOTP/DHCP". A confirmation is now displayed again in the "Errors and Warnings" window. Thus your device is in DHCP mode again.

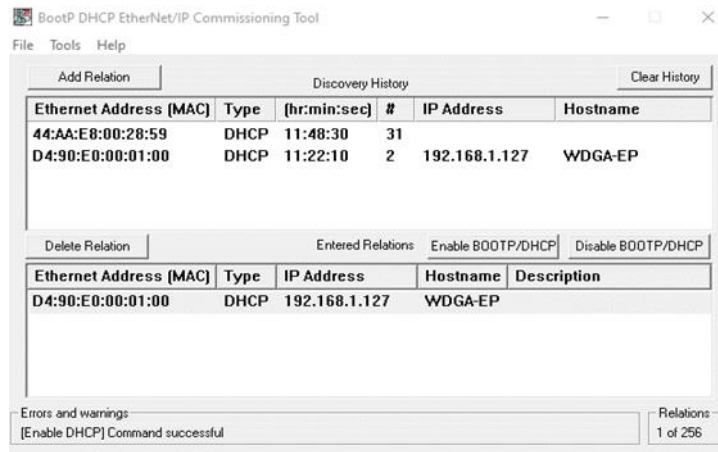



Figure 6.7: DHCP activated

## 6.4 Integration into a Studio 5000 project

Connect the device to your controller. Establish the voltage supply of the encoder.

	<ul style="list-style-type: none"> <li>Here it is assumed that you have already correctly configured your controller and the relevant network. If you have not yet done so, then first read the relevant manual and carry out commissioning accordingly.</li> </ul>
---	---

To include the encoder in Studio 5000, start it, open the desired project.

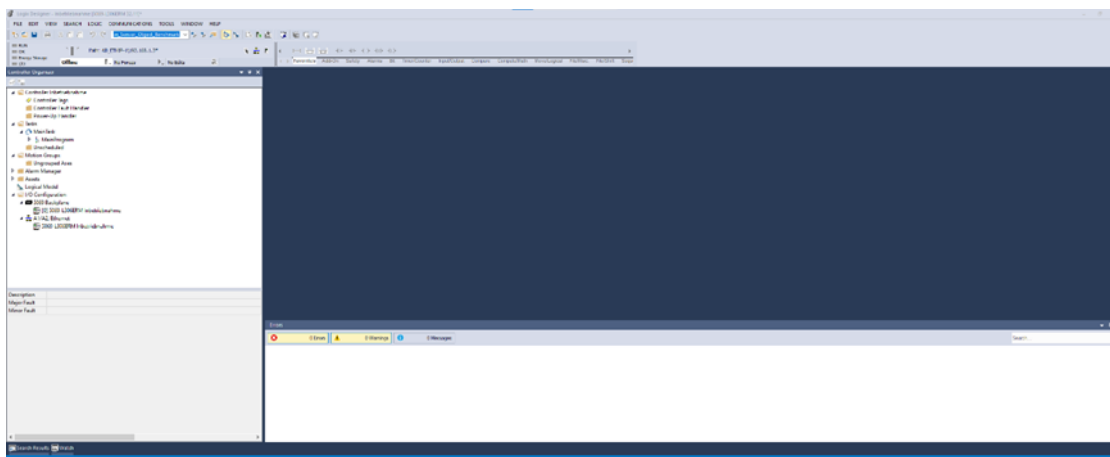

Figure 6.8: Main menu

You should now find yourself in the window shown in Figure 6.8. Then install the EDS file. You can download it from the download area of our website. To do this, open the "Tools" tab and select the "EDS Hardware Installation Tool" menu.

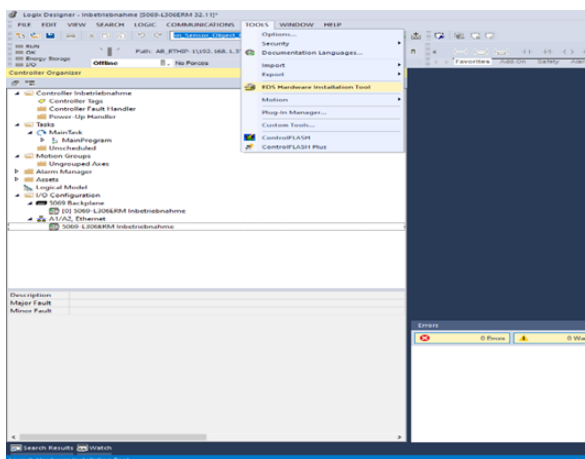

Figure 6.9: Tools -> EDS Hardware Installation Tool



The so-called "EDS Hardware Installation Tool" will now open. Click on "Next".

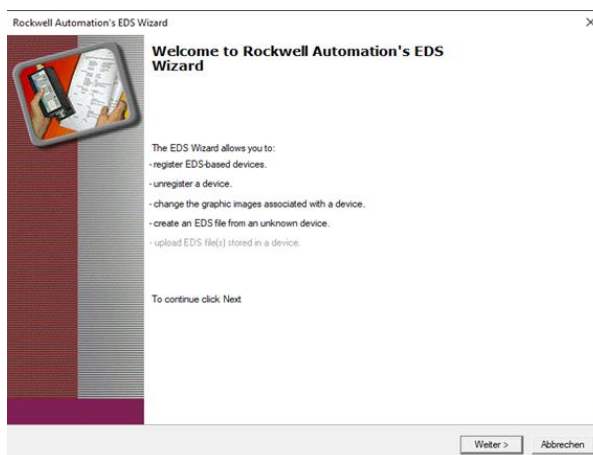

Figure 6.10: EDS Hardware Installation Tool

Select "Register and EDS file(s)" and click "Next" again.

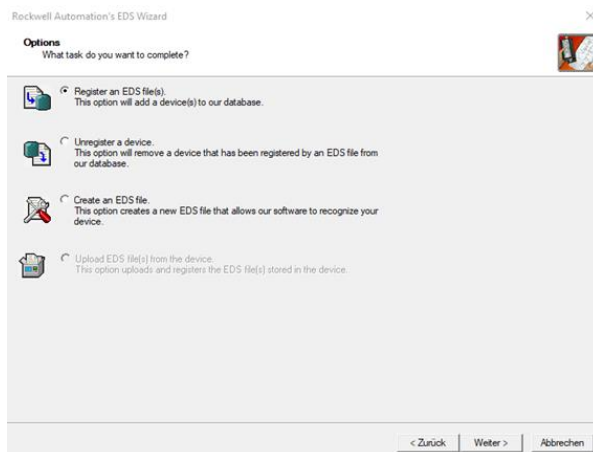

Figure 6.11: Register EDS file

Next, select "Register a single file" and paste the path of the EDS file. Then click on "Next" again..

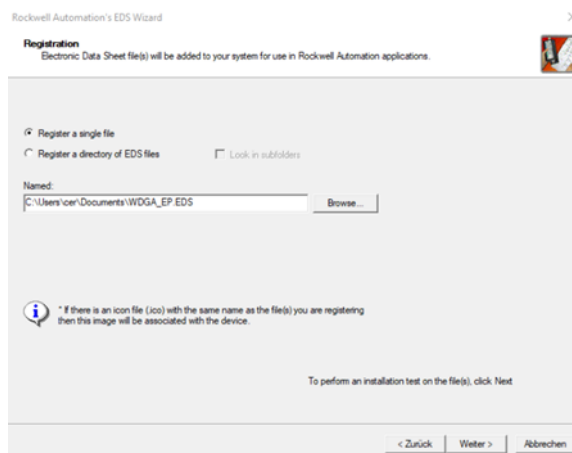

Figure 6.12: Pick EDS file

If you have selected the correct file, you should not have received an error message now. See Figure 6.13. Click "Next" again.

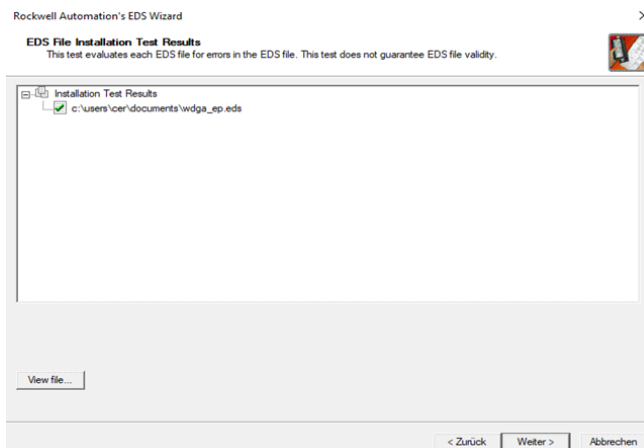

Figure 6.13: EDS installation

Now finish the installation by clicking on "Next" in the next two windows until you reach the window shown in Figure 6.14. Now click on "Finish". The installation of the EDS file is now finished.

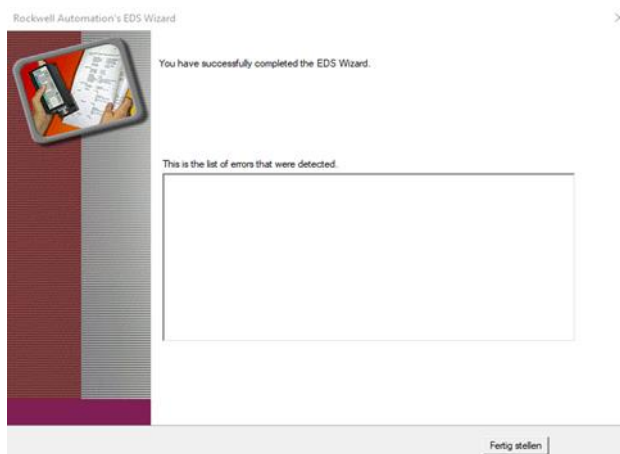

Figure 6.14: Installation successful

Now select the tab "A1/A2, Ethernet" in the left column of the Studio 5000 project navigation. The hardware view opens, and the hardware catalogue is now visible in the new window.

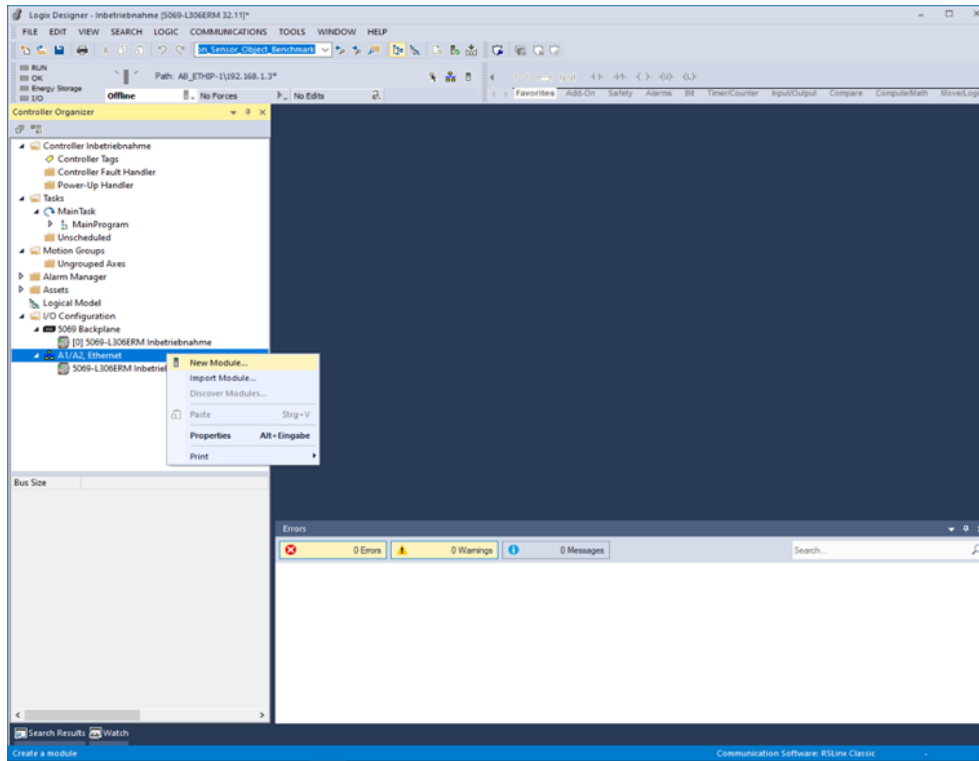

Figure 6.15: Project navigation

Search for "wdga" in the search bar and the WDGA-EP should now be displayed.  
Select the device and then click "Create".

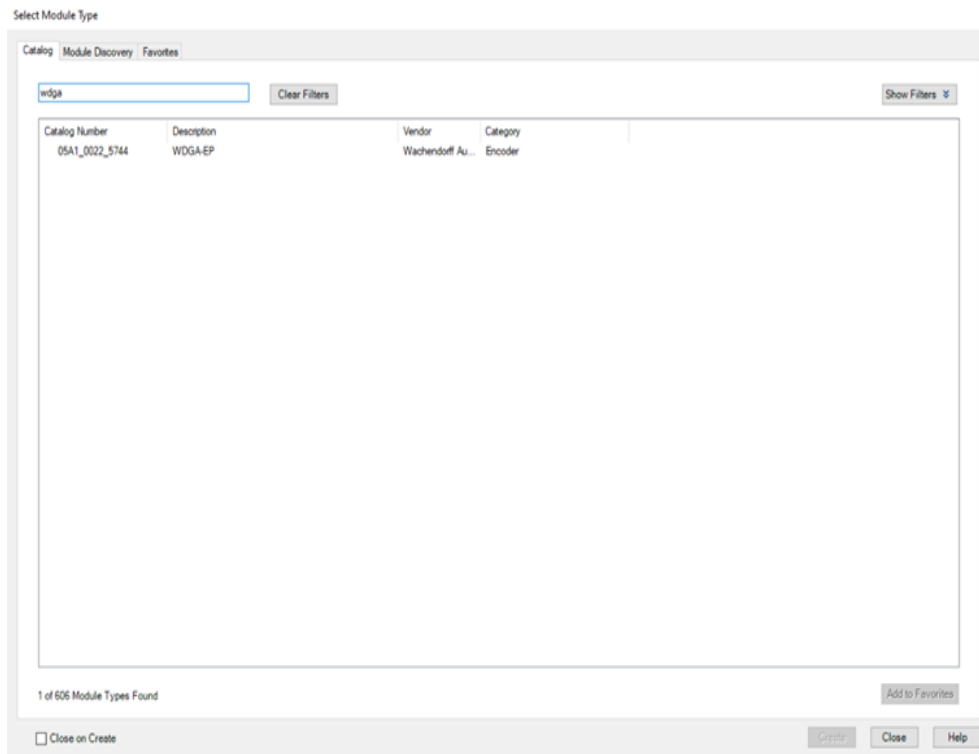

Figure 6.16: Hardware catalogue

A window opens again in which you can select the name, the IP address, the description (optional), and the assemblies. You can find out which assembly is suitable for you from the tables in 4.3.

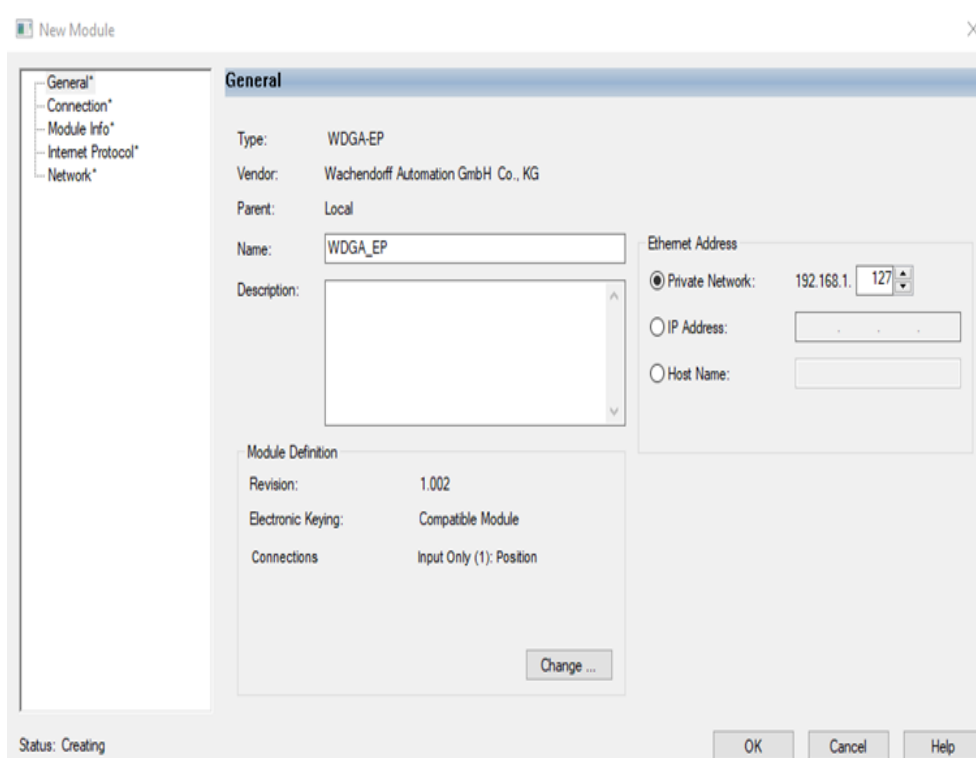

Figure 6.17: General

If you click on "Change ..." in the "General" window, you can set the assembly accordingly. In this chapter we will only work with Assembly 1 for the time being. We recommend to select DINT for "Size", so that you receive the position value as 32-bit block.

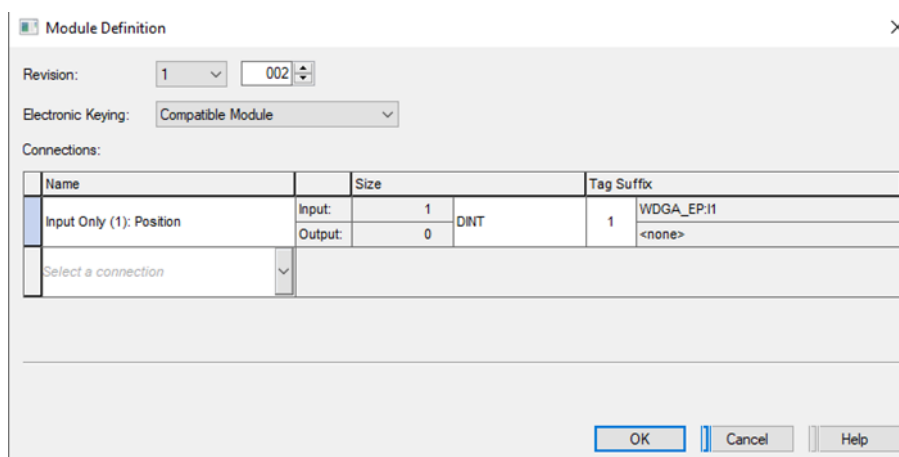

Figure 6.18: Choose assembly

Under the "Connection" tab you can now set the cycle time (RPI) and the "Connection over EtherNet/IP". Now click on "OK". The encoder should now be displayed in the left column of the project navigation.

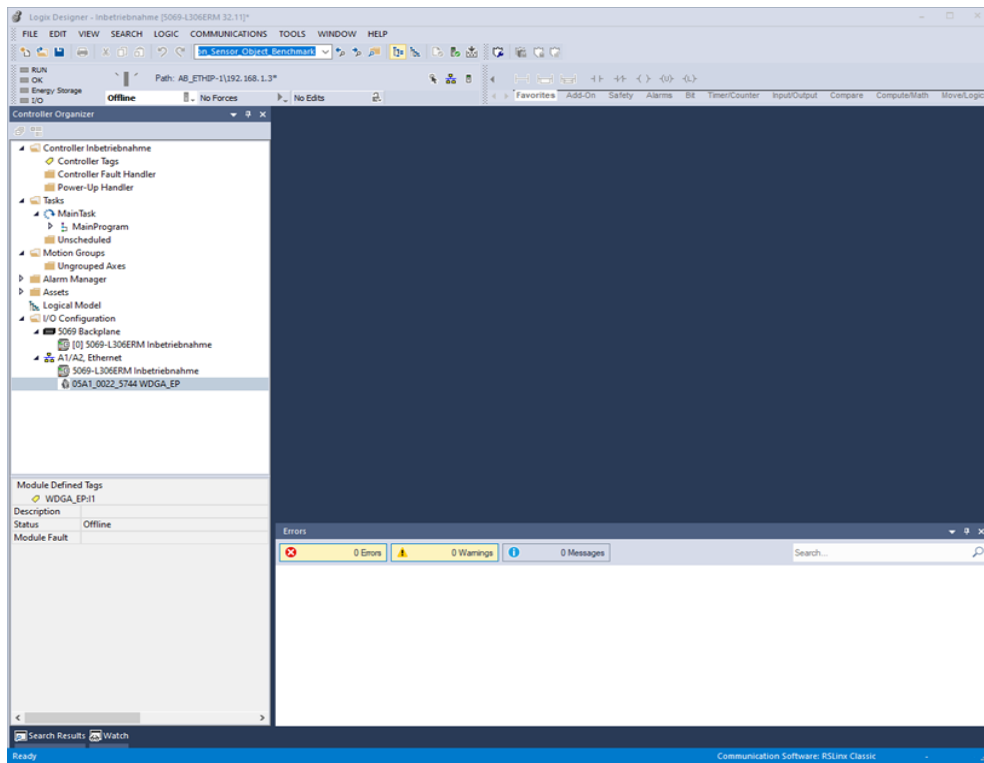

Figure 6.19: Encoder configuration successful

Now go online with the controller by downloading the program to the controller. Then navigate to the "Controller Tags" tab in the project navigation. Now first open the "WDGA:EP:I1" tab and then the "WDGA\_EP:I1.Data" tab. Under "WDGA\_EP:I1.Data[0]" you will now see the position value.

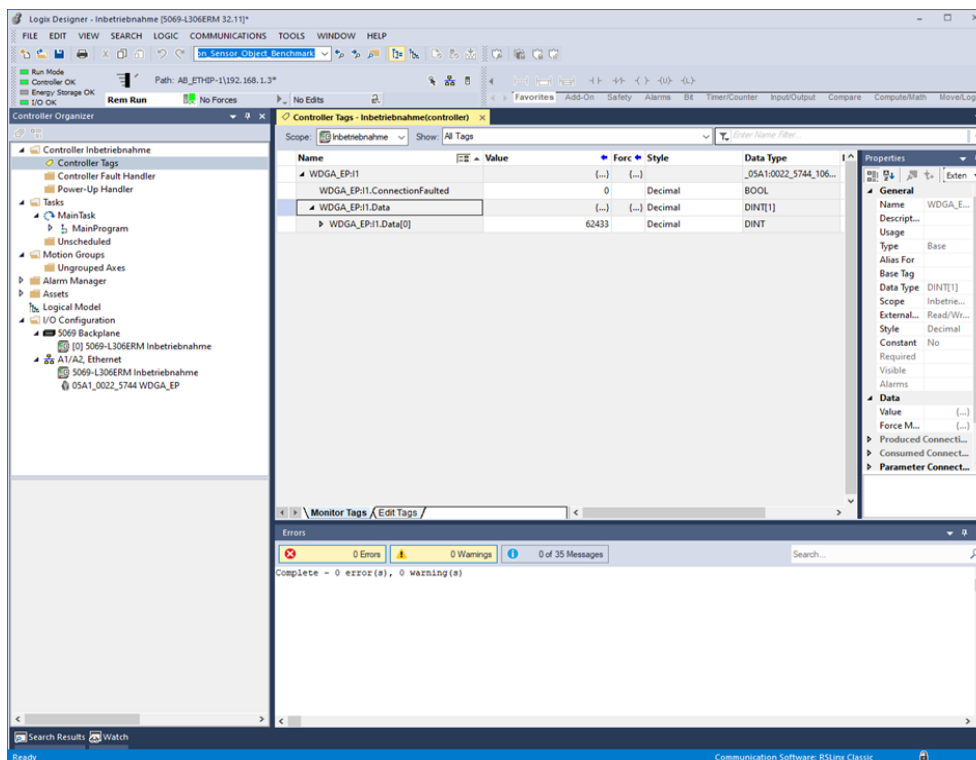



Figure 6.20: Position value

This concludes the integration of the encoder into the project for the time being. The following chapters will explain how you can configure the encoder according to your preferences. Two ways are shown for this.

## 6.4.1 Parameterization via Configuration Assembly

A one-time parameterization of the encoder can be carried out by means of the configuration assembly. The parameters are only adopted when a new connection is established, i.e. the config. assembly is not to be used during ongoing operation.



- After you have performed the one-time parameterization with the config. assembly, it is recommended to remove it again.

First open the "Module Properties" of the previously created device. Then select the "Change ..." button in the "General" window. Now select the connection "Input Only (101+110)" under "Connections" and confirm with "OK".

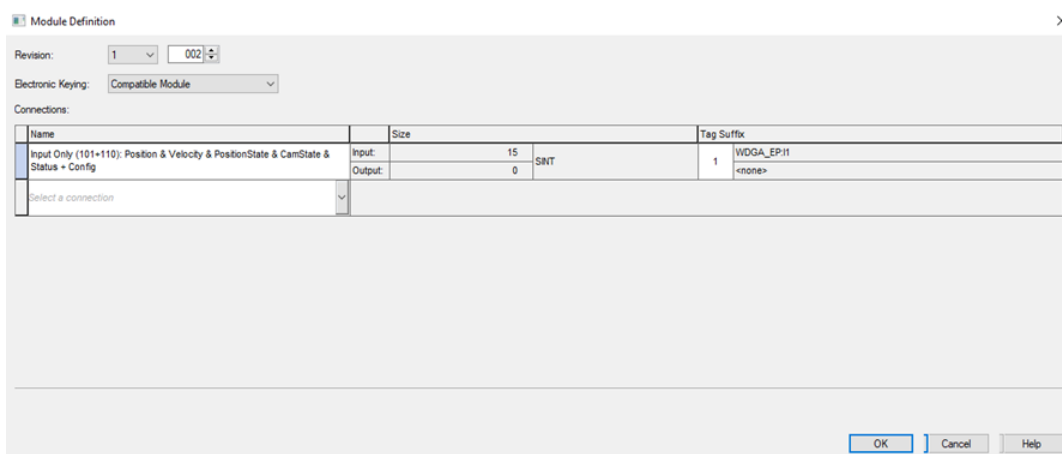

Figure 6.21: Module definition

This loads the assemblies 101 and 110 into the controller tags. Assembly 101 is used to view the process data, while Assembly 110 is used for configuration.

Now navigate to the controller tags. Under "WDGA\_EP:C" you will find the parameters to be set.

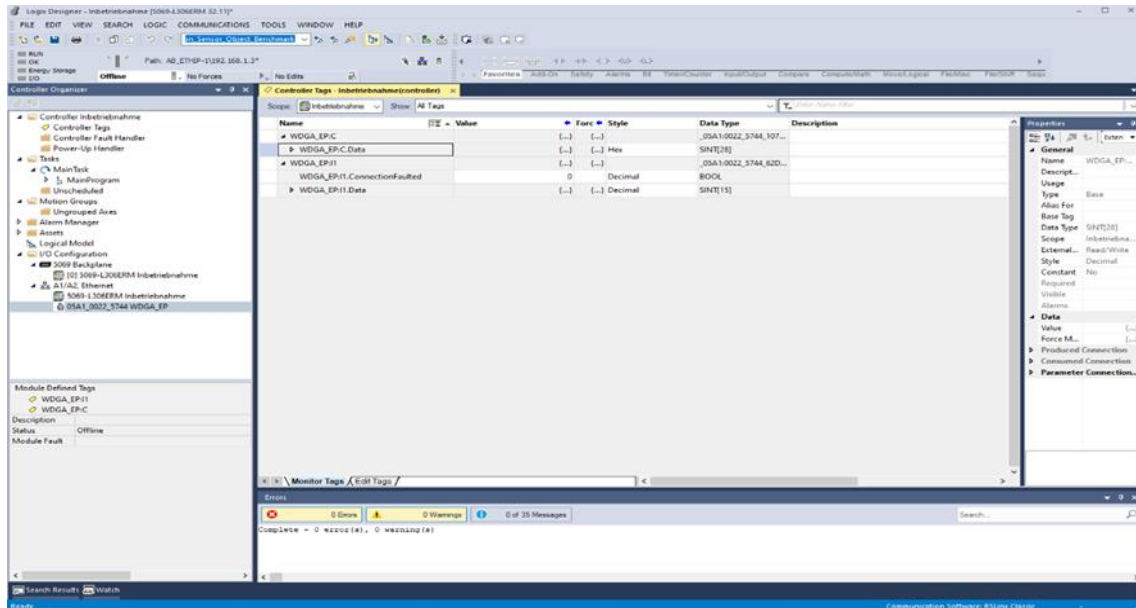

Figure 6.22: Controller tags

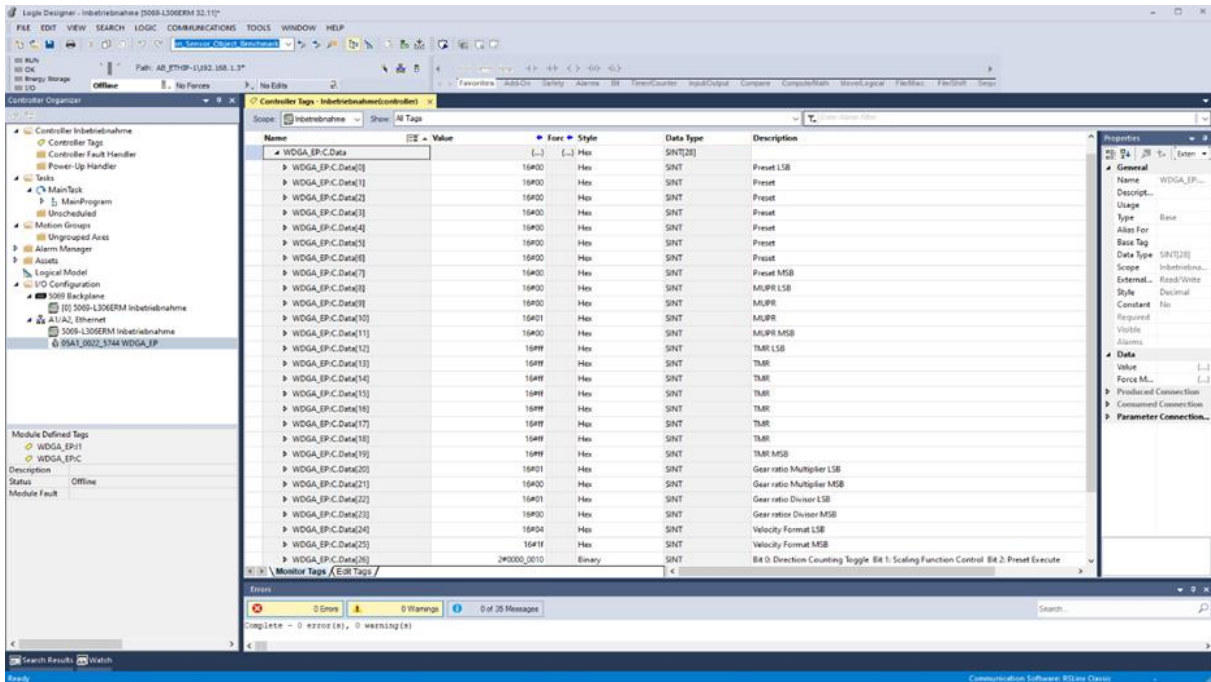

Figure 6.23: Configuration Assembly

Setting the data format to "Hex" is recommended. Here you can configure the parameters as desired. If you want to set e.g. the MUPR to 16-bit (65.536), the TMR to 32-bit (4.294.967.295) and the preset to 0, then set the first 8 bytes to 0, bytes 8 and 9 to FFh and bytes 12-15 also to FFh. In addition, you must set byte 26 to the value 06h, otherwise the preset will not be executed (bit 2 of byte 26 contains the preset execute).



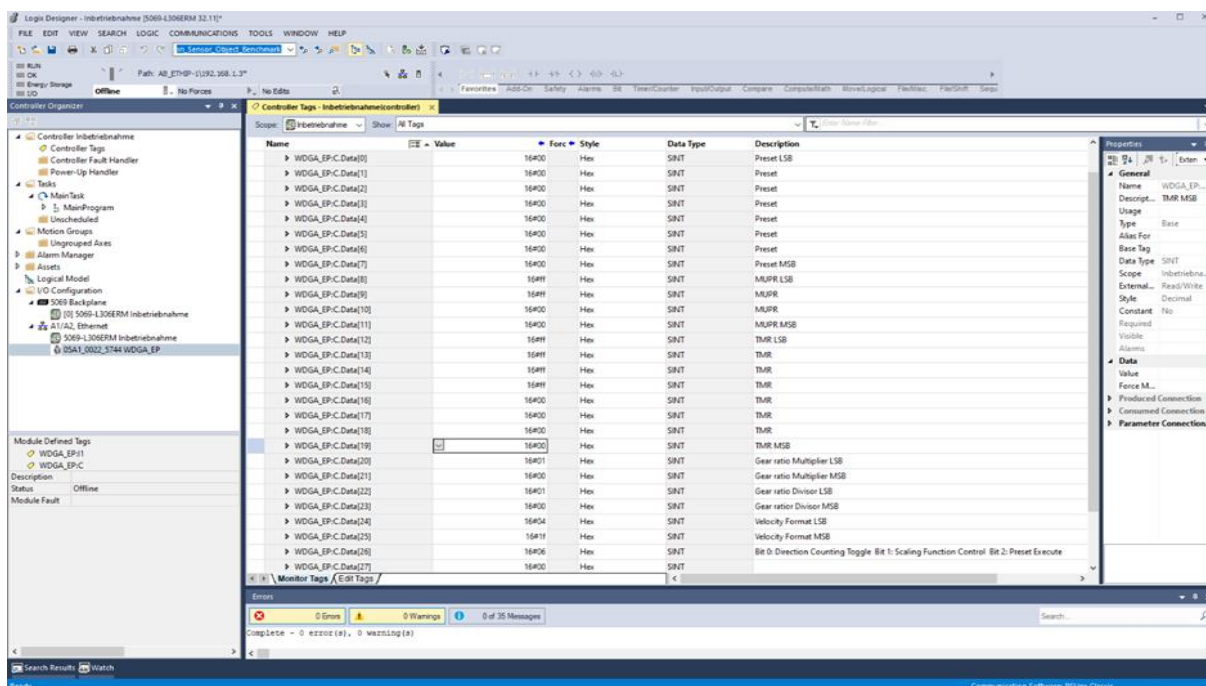

Figure 6.24: Example configuration

Now go online with the controller and download the program to the controller. As soon as the controller is online, you must establish a new connection with the device (preferably voltage reset). Then check, for example in the web server, whether your parameters have been saved.

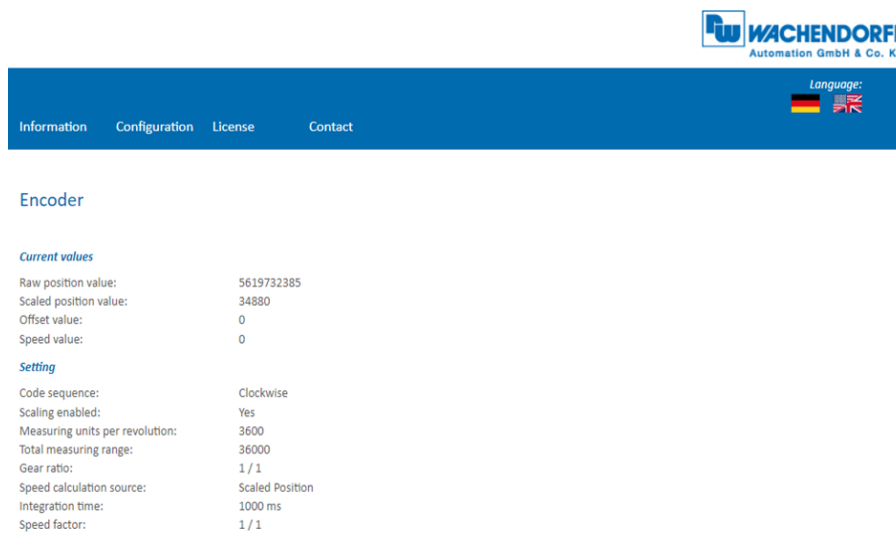

Figure 6.25: Encoder information

If all values have been accepted, the device is now fully commissioned and can be used.

## 6.4.2 Parameterization via Explicite Messaging

Explicite messaging treats each communication between devices as a separate request and response. Explicit messages can be sent by a client at any time and the server can respond as soon as it is available. Therefore, Explicit Messaging is used only for non-time-critical information, such as configuration data.

To parameterize the device using Explicit Messaging, first create a new PLC program (here: Ladder-Logic).

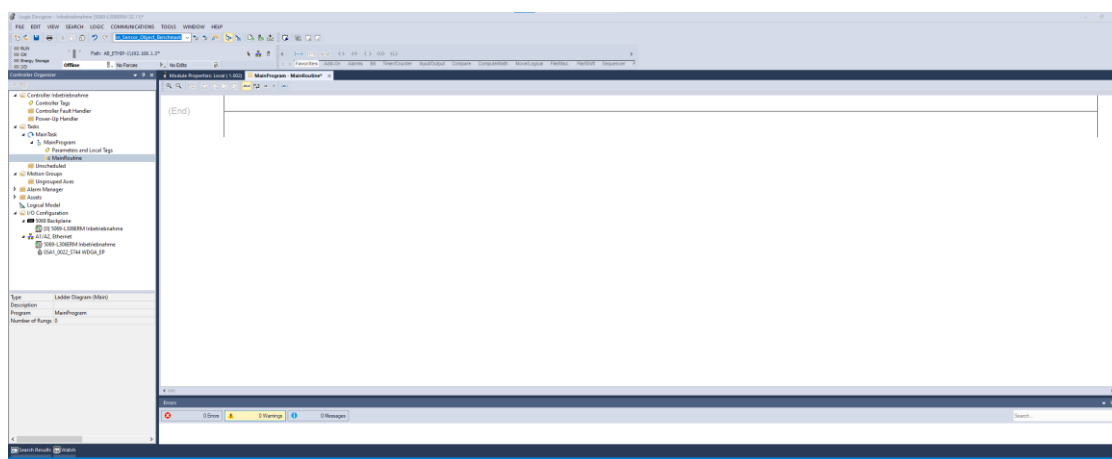

Figure 6.26: Example new program

Now add a device with the process data you require as described in chapter 6.4.

Then navigate back to your previously created program. Select "Parameters and Local tags" there.

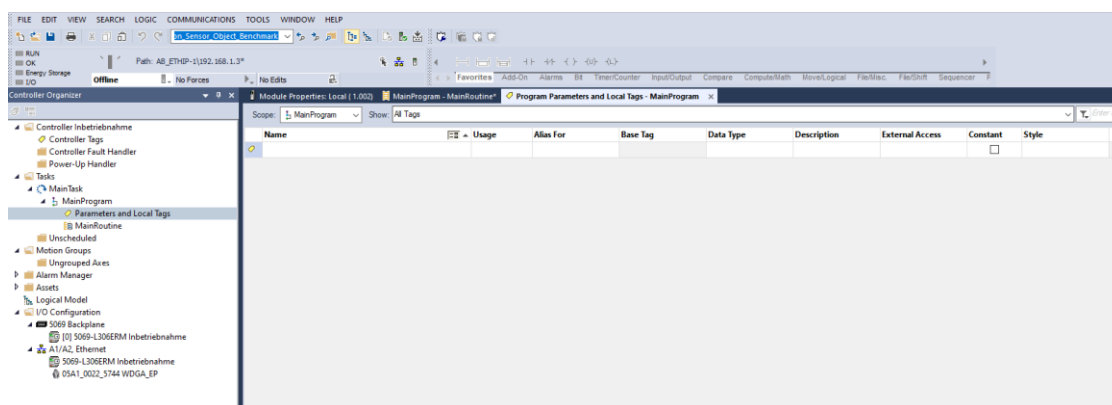

Figure 6.27: Parameters and tags

Now create the following tags to perform an example configuration:

- Send\_MSG\_TMR (Message)
- Send\_MSG\_TMR (Message)
- Send\_MSG\_Preset (Message)
- Send\_MSG\_Scaling (Message)
- TMR\_value (DINT)

- MUPR\_value (DINT)
- Preset\_value (DINT)
- Scaling\_toggle (SINT)

Name	Usage	Alias For	Base Tag	Data Type	Description	External Access	Constant	Style
Execute	Local			BOOL		Read/Write	<input type="checkbox"/>	Decimal
Execute_ONS	Local			BOOL		Read/Write	<input type="checkbox"/>	Decimal
MUPR_value	Local			DINT		Read/Write	<input type="checkbox"/>	Decimal
Preset_value	Local			DINT		Read/Write	<input type="checkbox"/>	Decimal
Scaling_toggle	Local			SINT		Read/Write	<input type="checkbox"/>	Decimal
Send_MSG_MUPR	Local			MESSAGE		Read/Write	<input type="checkbox"/>	
Send_MSG_Preset	Local			MESSAGE		Read/Write	<input type="checkbox"/>	
Send_MSG_Scaling	Local			MESSAGE		Read/Write	<input type="checkbox"/>	
Send_MSG_TMR	Local			MESSAGE		Read/Write	<input type="checkbox"/>	
TMR_value	Local			DINT		Read/Write	<input type="checkbox"/>	Decimal

Figure 6.28: Parameters and tags

Now switch back to your main program. First select the main strand and add a closer (XIC) using the key combination Alt + Ins.

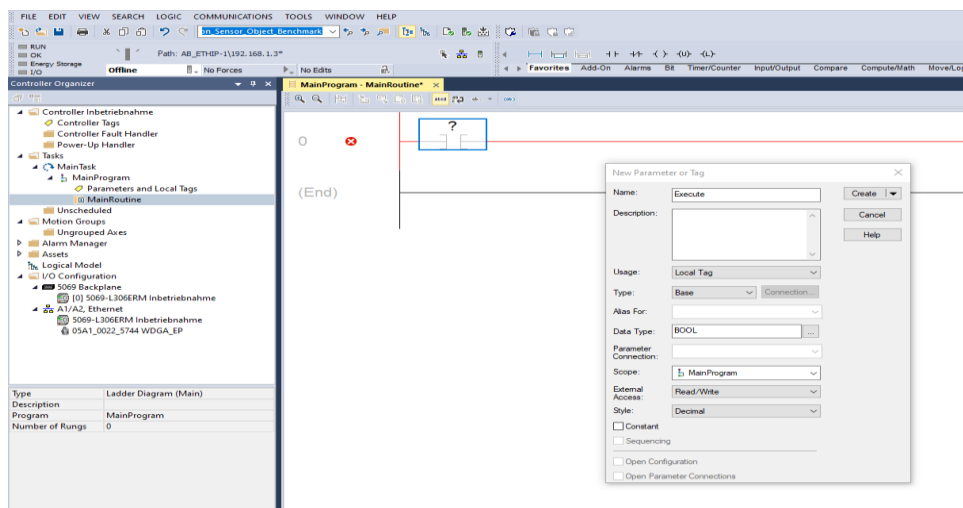

Figure 6.29: Rung edit

Then add a One Shot (ONS) by pressing Alt + Ins again.

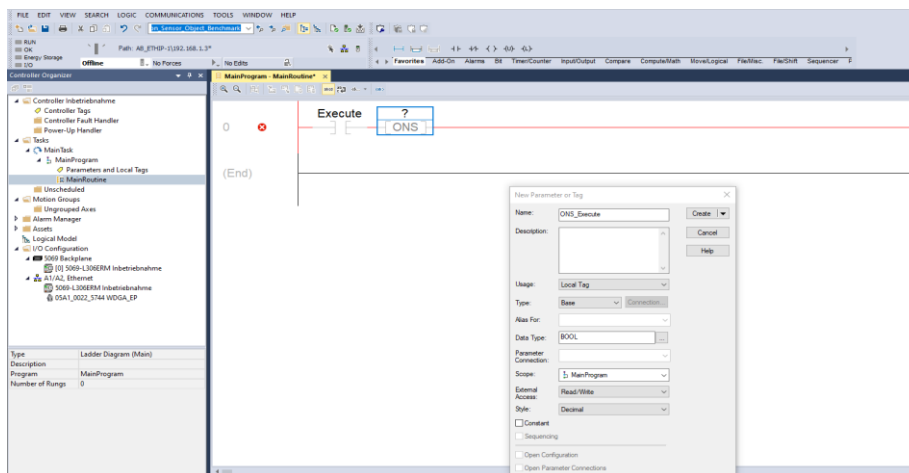

Figure 6.30: Rung edit

Next you add a MSG block. Then insert the name of the desired and previously created configuration into this block, e.g. TMR. Then click on the text box labeled "..." to enter the configuration of the MSG block.

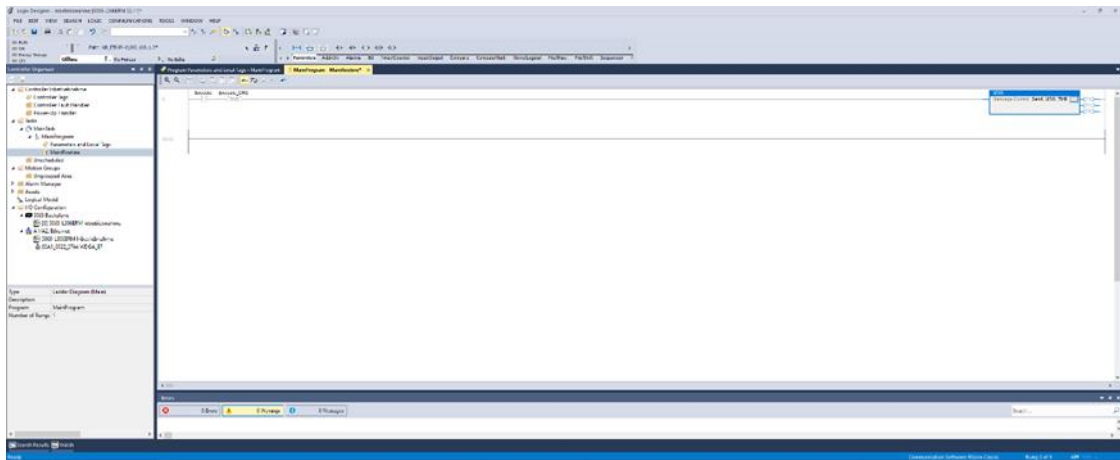

Figure 6.31: Rung edit

Configure the MSG block as shown in the figure below.

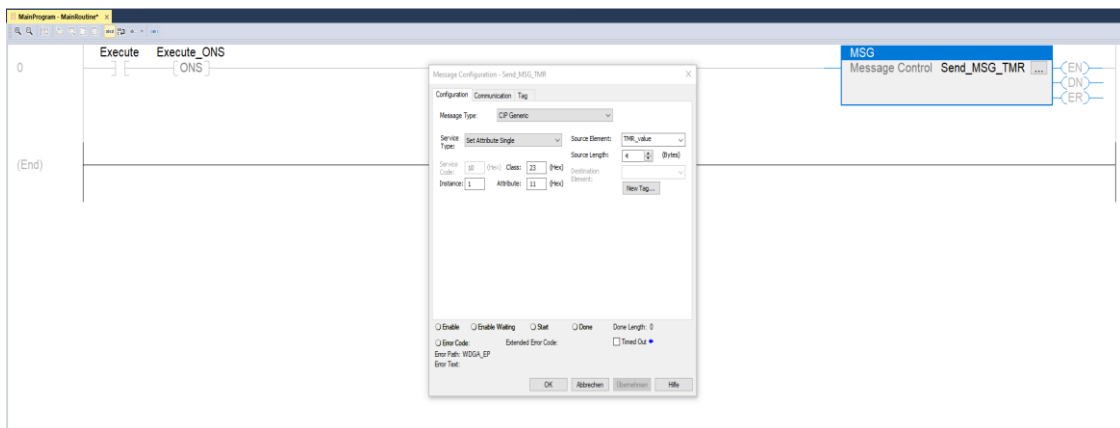

Figure 6.32: Rung edit

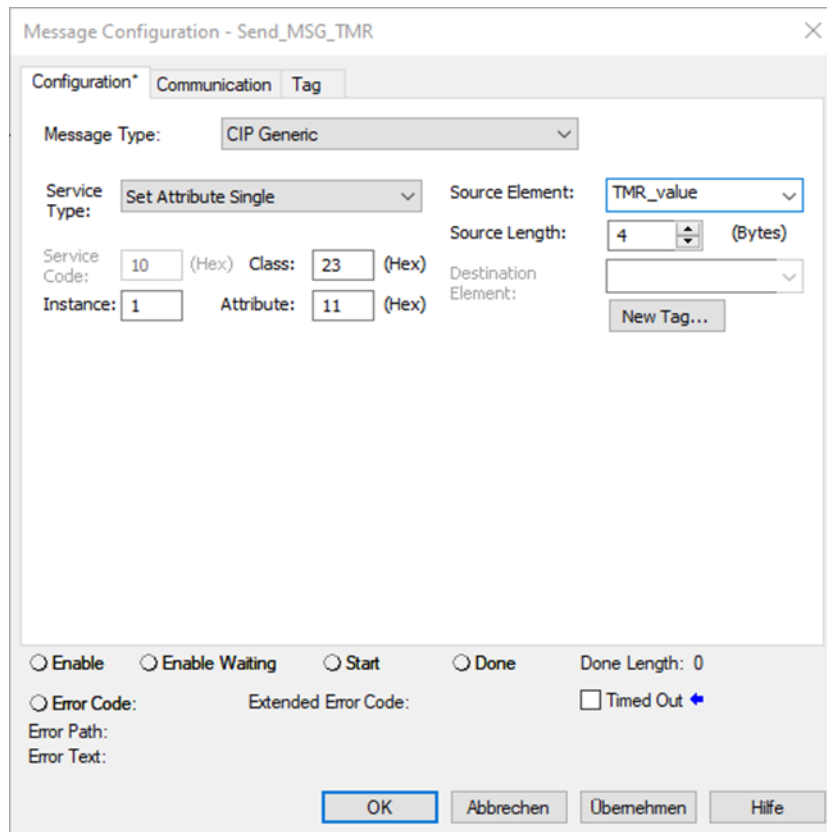

Figure 6.33: MSG block configuration

Under the "Communication" tab, select the encoder as the path.

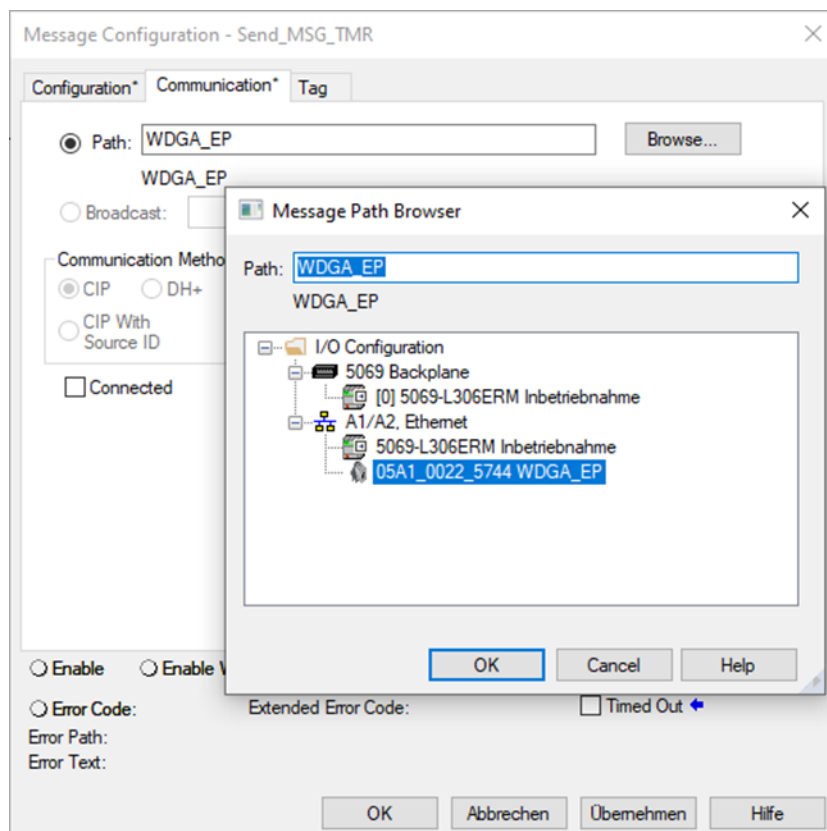

Figure 6.34: MSG block path configuration

Repeat this for all the tags you have created. Make sure that you assign the parameters correctly:

Attribut-ID	Message	Quelle	Bytes
<b>14 (Scaling)</b>	Send_MSG_Scaling	Scaling_toggle	1
<b>16 (MUPR)</b>	Send_MSG_MUPR	MUPR_value	4
<b>17 (TMR)</b>	Send_MSG_TMR	TMR_value	4
<b>19 (Preset)</b>	Send_MSG_Preset	Preset_value	4

Table 6.1: Configurations

After you have created and configured everything, your program should look like the one shown below.

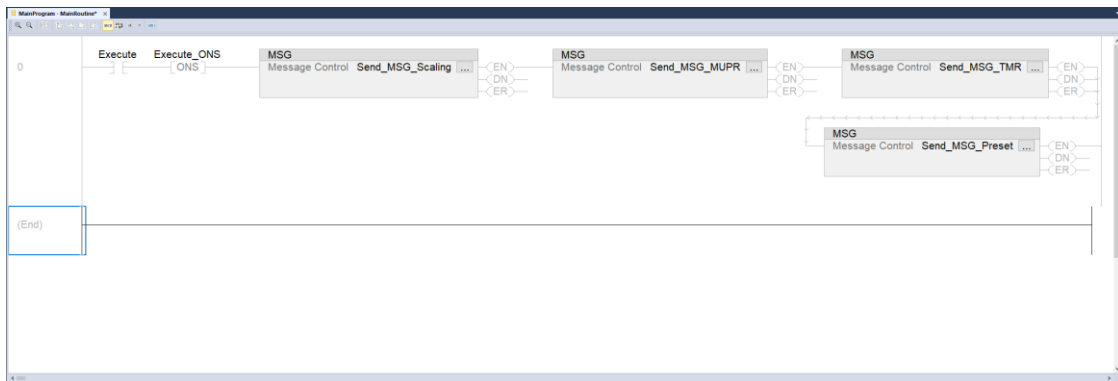

Figure 6.35: Configure main program

Now go online with the controller and download the program you just edited. Then navigate back to the "Program Parameters and Local Tags" tab. Now enter the values you want.

For example, if you want to activate the scaling, define a shaft revolution with 0.1°, set the total measuring range to 10 revolutions and have the position value start at 0, then make the following settings.

Name	Usage	Value	Forc	Style	Data Type	Description
Send_MSG_TMR	Local		{...}	{...}	MESSAGE	
Send_MSG_MUPR	Local		{...}	{...}	MESSAGE	
Send_MSG_Preset	Local		{...}	{...}	MESSAGE	
Send_MSG_Scaling	Local		{...}	{...}	MESSAGE	
TMR_value	Local	16#0000_8ca0		Hex	DINT	
MUPR_value	Local	16#0000_0e10		Hex	DINT	
Preset_value	Local	16#0000_0000		Hex	DINT	
Scaling_toggle	Local	16#01		Hex	SINT	
Execute	Local	16#0		Hex	BOOL	
Execute_ONS	Local	16#0		Hex	BOOL	

Figure 6.36: Parameters and tags

Now switch back to your main program and activate the "Execute" closer by selecting it and pressing Ctrl + T.

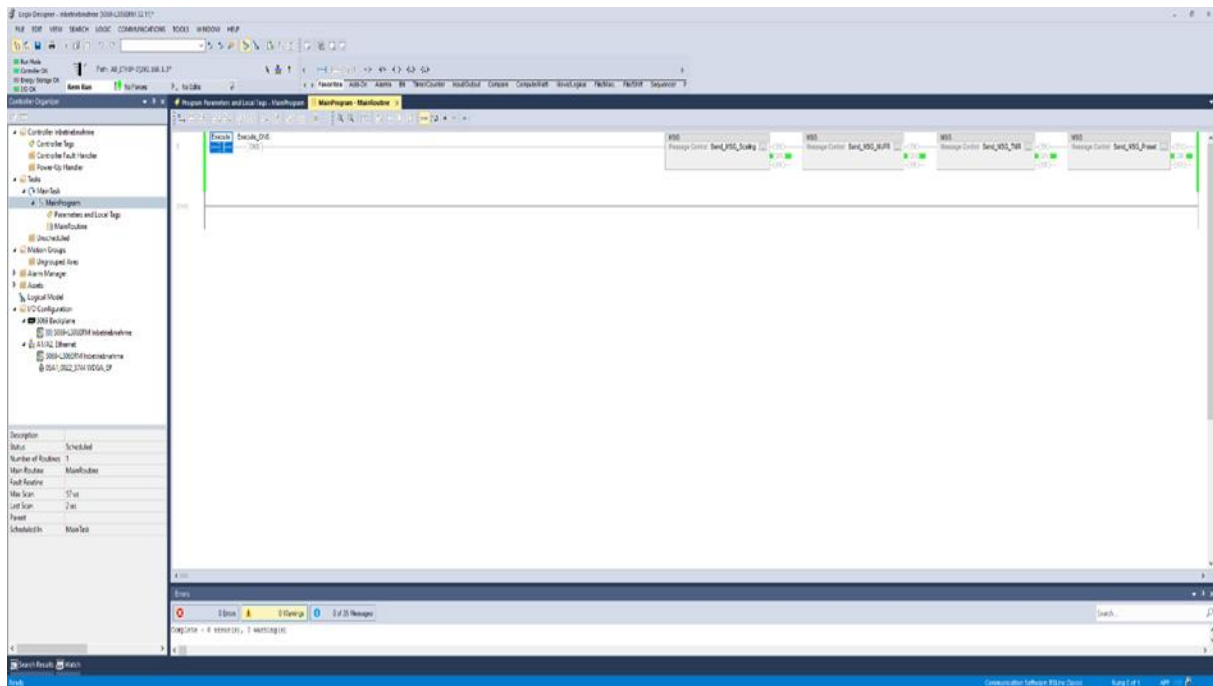





Figure 6.37: Configuration successful

If everything was successful, then each MSG block is in DN state. Check your settings by looking at the web server, for example.



Information
Configuration
License
Contact

Language:  



### Encoder

*Current values*

Raw position value:	5619732385
Scaled position value:	34880
Offset value:	0
Speed value:	0

*Setting*

Code sequence:	Clockwise
Scaling enabled:	Yes
Measuring units per revolution:	3600
Total measuring range:	36000
Gear ratio:	1 / 1
Speed calculation source:	Scaled Position
Integration time:	1000 ms
Speed factor:	1 / 1

Figure 6.38: Webservice after successful configuration

## 6.5 Further exemplary configuration options

### 6.5.1 Position limits

If you need software limit switches, it is recommended to use Position Low/High Limits. To use these, proceed as described in Chapter 6.4.2. Select the desired values for the limits, e.g. Low Limit = 500, High Limit = 1500. Configure the messages as shown below.

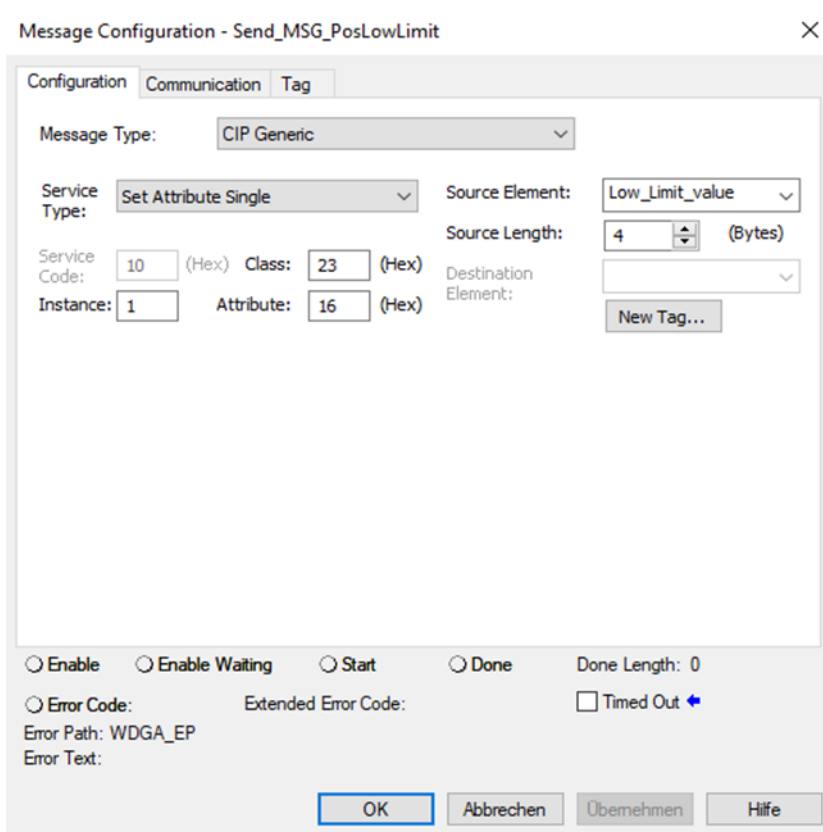

Message Configuration - Send\_MSG\_PosLowLimit

Configuration Communication Tag

Message Type: CIP Generic

Service Type: Set Attribute Single

Service Code: 10 (Hex) Class: 23 (Hex) Instance: 1 Attribute: 16 (Hex)

Source Element: Low\_Limit\_value

Source Length: 4 (Bytes)

Destination Element:

New Tag...

Enable  Enable Waiting  Start  Done Done Length: 0

Error Code: Extended Error Code:  Timed Out

Error Path: WDGA\_EP

Error Text:

OK Abbrechen Übernehmen Hilfe

Figure 6.39: Message position low limit



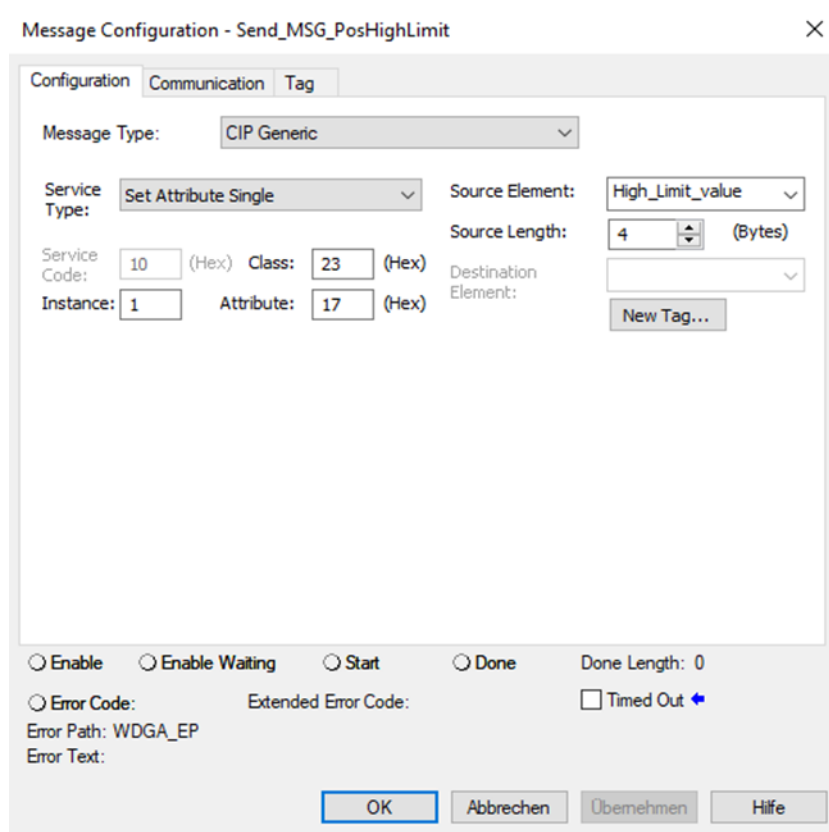

Figure 6.40: MSG position high limit

Then navigate to the encoder configuration and select Assembly 100.

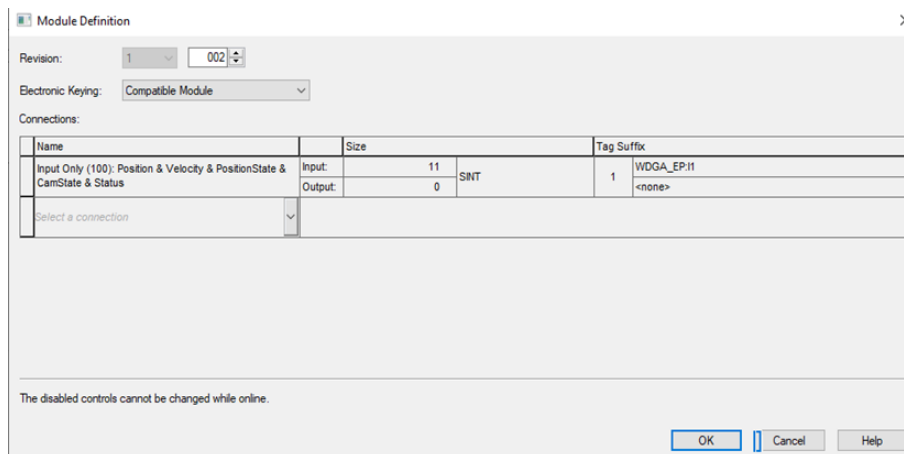
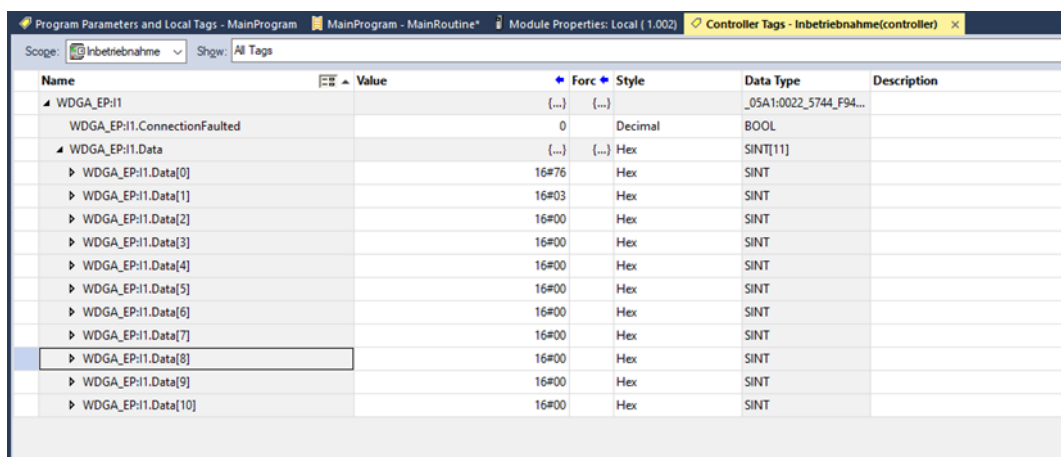

Figure 6.41: Assembly 100

Now switch back to the "Controller Tags". Under "WDGA\_EP:I1.Data[8]" you can now see whether you are inside or outside the work area.



Name	Value	Forc	Style	Data Type	Description
WDGA_EP:I1		(...)	(...)	_05A1:0022_5744_F94...	
WDGA_EP:I1.ConnectionFaulted	0		Decimal	BOOL	
WDGA_EP:I1.Data		(...)	(...)	SINT[11]	
WDGA_EP:I1.Data[0]	16#76		Hex	SINT	
WDGA_EP:I1.Data[1]	16#03		Hex	SINT	
WDGA_EP:I1.Data[2]	16#00		Hex	SINT	
WDGA_EP:I1.Data[3]	16#00		Hex	SINT	
WDGA_EP:I1.Data[4]	16#00		Hex	SINT	
WDGA_EP:I1.Data[5]	16#00		Hex	SINT	
WDGA_EP:I1.Data[6]	16#00		Hex	SINT	
WDGA_EP:I1.Data[7]	16#00		Hex	SINT	
WDGA_EP:I1.Data[8]	16#00		Hex	SINT	
WDGA_EP:I1.Data[9]	16#00		Hex	SINT	
WDGA_EP:I1.Data[10]	16#00		Hex	SINT	

Figure 6.42: Position state register inside work are

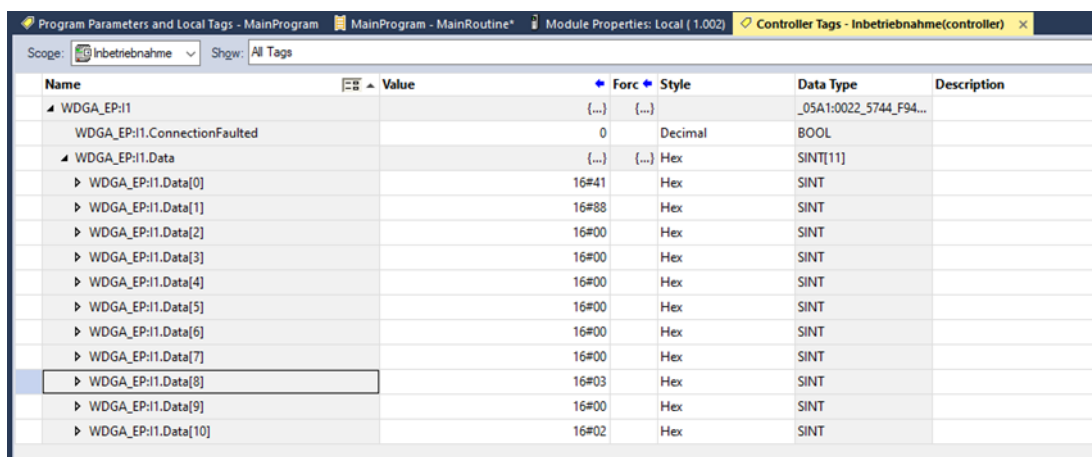

Name	Value	Forc	Style	Data Type	Description
WDGA_EP:I1		(...)	(...)	_05A1:0022_5744_F94...	
WDGA_EP:I1.ConnectionFaulted	0		Decimal	BOOL	
WDGA_EP:I1.Data		(...)	(...)	SINT[11]	
WDGA_EP:I1.Data[0]	16#41		Hex	SINT	
WDGA_EP:I1.Data[1]	16#88		Hex	SINT	
WDGA_EP:I1.Data[2]	16#00		Hex	SINT	
WDGA_EP:I1.Data[3]	16#00		Hex	SINT	
WDGA_EP:I1.Data[4]	16#00		Hex	SINT	
WDGA_EP:I1.Data[5]	16#00		Hex	SINT	
WDGA_EP:I1.Data[6]	16#00		Hex	SINT	
WDGA_EP:I1.Data[7]	16#00		Hex	SINT	
WDGA_EP:I1.Data[8]	16#03		Hex	SINT	
WDGA_EP:I1.Data[9]	16#00		Hex	SINT	
WDGA_EP:I1.Data[10]	16#02		Hex	SINT	

Figure 6.43: Position state register outside work area

## 6.5.2 Preset Attribut 140h

If you have already executed a preset, as explained in Chapter 6.4.2, you can use "preset execute" to set the position value to the previously defined preset value again. Proceed as explained in the previous chapters.

## 7 Technical data

### 7.1 Properties

<b>Interfaces</b>	1x M12 ports 4-pole D-coded	
	2x M12 connector 4-pole A-coded	
<b>Profinet data rate</b>	Max. 100 Base-TX	
<b>Diagnostic LEDs</b>	Data traffic and connection monitoring:	L/A1: Port 1, L/A2: Port 2
<b>Status LEDs</b>	Status display for encoder and bus	MOD
<b>Operating temperature</b>	-40°C to +85°C	
<b>Storage temperature</b>	-40°C to +125 °C	
<b>Operating voltage</b>	10 VDC to 32 VDC	
<b>Current consumption</b>	typ. 125 mA	
<b>Power consumption</b>	typ. 3 W	
<b>Weight</b>	WDGA 58B, 58F:	approx. 700 g
	WDGA 58E:	approx. 410 g
	WDGA 58A:	approx. 700g
	WDGA 58D:	approx. 700g
<b>Housing</b>	Flange material:	Aluminium
	Flange material (rear):	Steel housing, chromium-plated, magnetically shielded
	Connection hood:	Die-cast aluminium, powder-coated

## 7.2 Dimensions

### 7.2.1 WDGA 58B

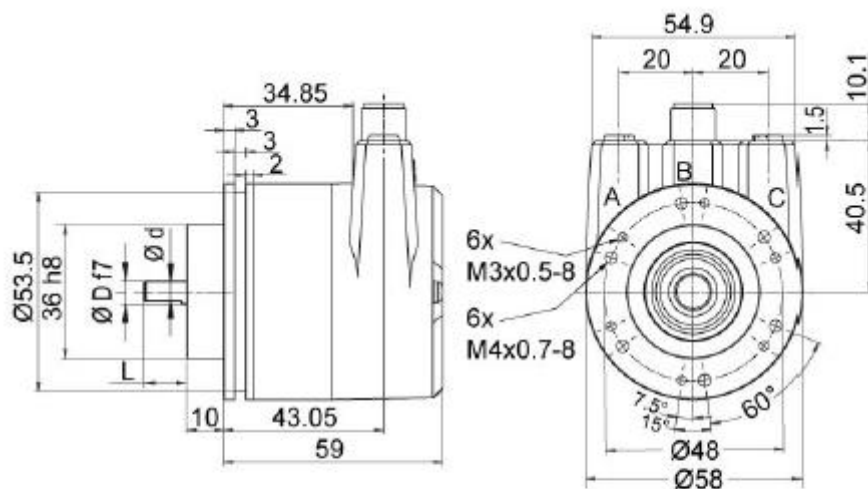

D = 6, L = 12, d = 5.3 shaft with flat  
 D = 8, L = 20, d = 7.5 shaft with flat  
 D = 10, L = 20, d = 10 shaft without flat  
 D = 3/8", L = 20, d = 8.3 shaft with flat

\*option full IP67 version: D = 10 mm  
 D = 10, L = 20, d = 9 shaft with flat

Figure 7.1: Dimensions WDGA 58B

### 7.2.2 WDGA 58F

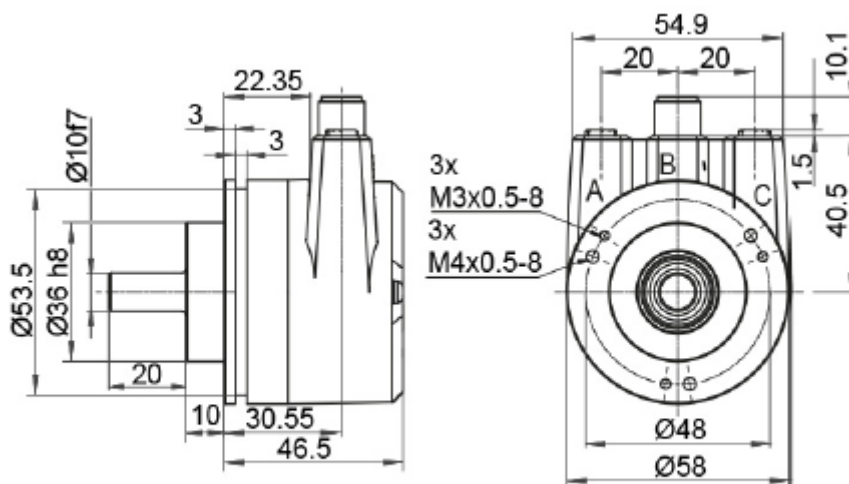

Figure 7.2: Dimensions WDGA 58F

### 7.2.3 WDGA 58E

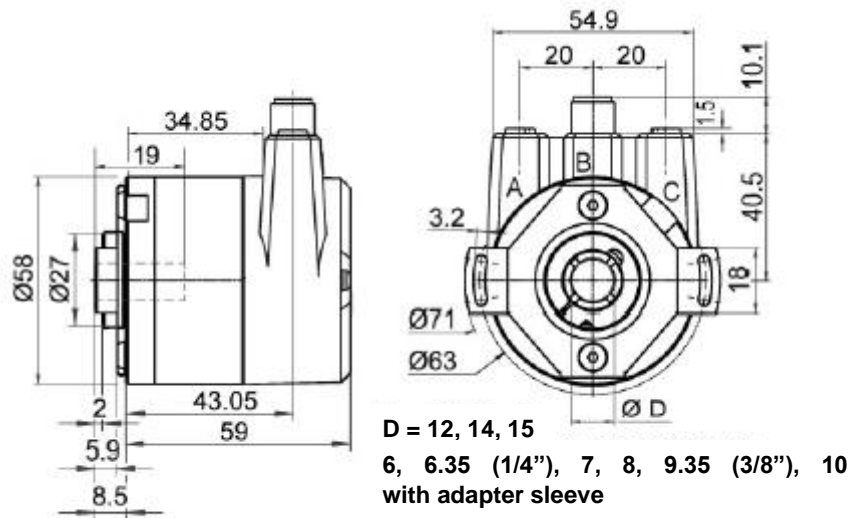
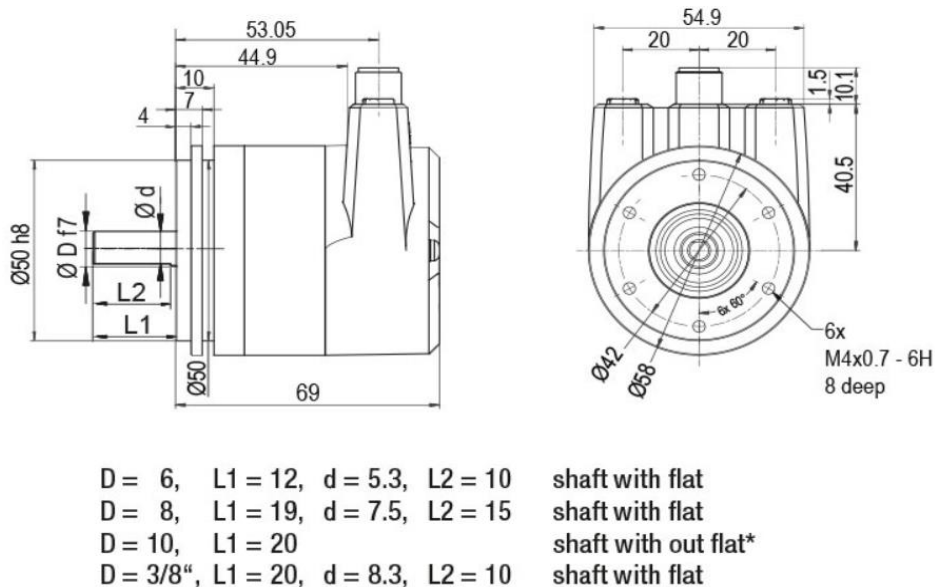

Figure 7.3: Dimensions WDGA 58E

### 7.2.4 WDGA 58A



\* Option full IP67 version: (only D = Ø 10 mm)  
D = 10, L1 = 20, d = 9, L2 = 15 shaft with flat

Option AIX:  
D = 6, L1 = 10, d = 5.3, L2 = 8 shaft with flat

Figure 7.4: Dimensions WDGA 58A

## 7.2.5 WDGA 58D

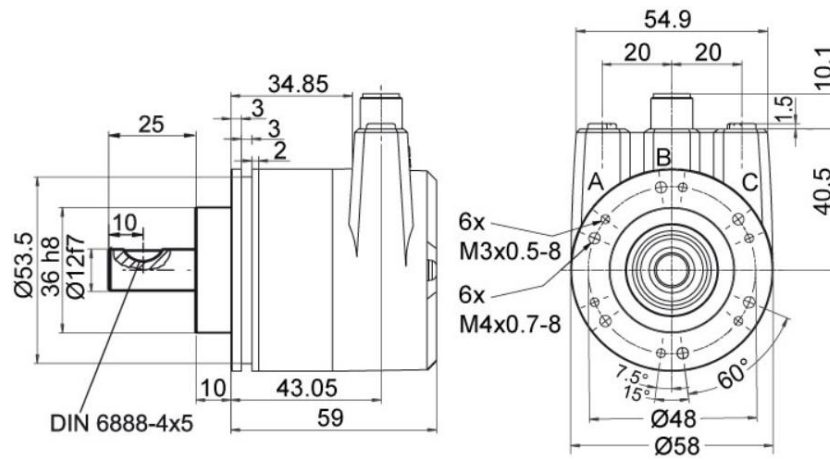

Figure 7.5: Dimension WDGA 58D

## 8 Technical support

### Technical application advisor

Do you have any questions about this product?

Our technical application advisor will be pleased to help you.

Tel.: +49 (0) 67 22 / 99 65 414  
E-Mail: [support-wa@wachendorff.de](mailto:support-wa@wachendorff.de)

Notes: